

Honeywell

THE POWER OF **CONNECTED**

Sensors and Switches for Medical Applications



Potential Applications Overview

Potential Application	Honeywell Product	Product Function in Application	Customer Benefits
RESPIRATORY			
Anesthesia Delivery Machines	Airflow Sensors	Measure air, oxygen, and nitrous oxide flow so that the specified mixture, as set by the doctor, is delivered to the patient	accurate, customizable, stable, low pressure drop, saves time and money
	Hall-effect Position Sensor ICs	Provide enhanced output accuracy for smooth motor control that reduces noise and vibration in motor assembly fan systems	quiet, cost-effective, efficient, effective, accurate
	Humidity Sensors	Deliver warm and moist air to enhance patient comfort	accurate, flexible, cost effective, durable
	Pressure Sensors – Board Mount	Measure air and oxygen pressure so that the pressure doesn't exceed a desired level	stable, easy to use, accurate, improves patient safety, easy to design in, compatible
	Pressure Transducers – Heavy Duty		
	Thermistor Sensing Elements, Packaged Temperature Probes	Monitor and control air temperature	flexible, cost-effective, small size
Oxygen Concentrators	Airflow Sensors	Detect ultra-low levels at 0.1 cm ³ to determine when the patient exhales and when the system should reduce airflow	improves patient comfort, eases patient breathing, quiet, portable, reliable
	Pressure Sensors – Board Mount	Detect when the patient begins to inhale so that oxygen can then be delivered efficiently and effectively	stable, sensitive, accurate, reliable, cost-effective, efficient
	Pressure Transducers – Heavy Duty	Sense pressure from the surge tank, providing feedback to the compressor which allows the compressor to maintain the desired pressure level	sensitive, accurate, reliable, cost-effective, efficient
	Pressure Switches	Acts as a high pressure warning, alerting the user by activating an indicator light when the pressure exceeds a specified limit	accurate, reliable, extended life, one-stop shopping
Sleep Apnea Machines	Airflow Sensors	Monitor the patient's breathing and send an output that reduces the flow of the machine's internal blower fan when the patient starts to exhale	improves patient comfort, eases patient breathing, quiet, portable, reliable
	Hall-effect Position Sensor ICs	Provide enhanced output accuracy for smooth motor control that reduces noise and vibration in motor assembly fan systems	quiet, cost-effective, improves patient safety, efficient, effective, accurate
	Humidity Sensors	Monitor the amount of humidified air to provide adequate air moisture to the patient	accurate, flexible, cost-effective, durable
	Pressure Sensors – Board Mount	Monitor the air pressure that is delivered to the patient	stable, reliable, efficient, accurate, sensitive
	Thermistor Sensing Elements, Packaged Temperature Probes	Provide warm, moist air to enhance patient comfort	accurate, effective design, flexible
	Thermostat	Onboard devices on flexible heaters for temperature control	customizable, flexible, small
Ventilators	Airflow Sensors	Measure the flow of air and oxygen so that the specified mixture, as set by the doctor, is delivered to the patient	accurate, customizable, stable, low pressure drop, saves time and money
	Hall-effect Position Sensor ICs	Provide enhanced output accuracy for smooth motor control that reduces noise and vibration in motor assembly fan systems	quiet, cost-effective, improves patient safety, efficient, effective, accurate
	Humidity Sensors	Help deliver warm and moist air by being coupled to a microcontroller designed to measure the humidity of the air stream and signal the controller that the desired level of moisture is present	accurate, flexible, cost-effective, durable
	Packaged Temperature Probes	Monitor air temperature	flexible, customizable
	Pressure Sensors – Board Mount	Measure air and oxygen pressure so that the pressure doesn't exceed a desired level	stable, easy to use, accurate, improves patient safety, easy to design in
	Pressure Transducers – Heavy Duty	Provide a sensing solution when high pressure, steel pressure port interface and/or corrosive media are used	easy to use, accurate, improves patient safety, easy to design in
	Thermistor Sensing Elements	Monitor and control the air temperature	flexible, cost-effective, small
KIDNEY DIALYSIS MACHINES			
Kidney Dialysis Machines	Force Sensors	a) Detect the presence or absence of a fresh dialysate cartridge before the machine can be used b) Monitor the flexible tubing pressure of the dialysate to detect that the pressure doesn't exceed a specified level c) Monitor the weight of the dialysate to detect whether there is a specified amount of dialysate in the fresh dialysate cartridge	reliable, sensitive, stable
	Hall-effect Position Sensor ICs	Provide reliable, accurate output for smooth motor control that reduces noise and vibration in the machine's motor assembly and improves its efficiency	quiet, cost-effective, energy-efficient, accurate
	Pressure Sensors – Board Mount	Obtain a direct, in-line continuous dialysate and venous pressure measurement in the dialysis membrane without interrupting flow	stable, efficient, accurate, easy to design in, small, extended life
	Pressure Transducers – Heavy Duty	When located in a cartridge, may be used to monitor pressure in the flexible tubing that carries blood or dialysate to provide continuous feedback of line pressures and pump control	
	Thermistor Sensing Elements	Provide temperature measurement for enhanced control of the permeation rate across the dialysis membrane	flexible, cost-effective, small

Potential Application	Honeywell Product	Product Function in Application	Customer Benefits
INFUSION, INSULIN, AND SYRINGE PUMPS			
Infusion, Insulin, and Syringe Pumps	Force Sensors	Provide an occlusion detector to detect blockage in the infusion or insulin pump's tube that delivers the medication to the patient	sensitive, stable, reliable, easy to use, portable
	Magnetic Position Sensor ICs	Provide reliable, accurate output for smooth motor control that reduces noise and vibration in the pump's motor assembly and improves its efficiency	quiet, cost-effective, energy-efficient, accurate
	Pressure Sensors – Board Mount	Monitor and control fluid flow	accurate, easy to design in, stable
	OEM 2D Scan Engines	Provide barcode scanning ability, helping to verify treatment procedures as they are delivered	small, optimized white illumination, enhanced scan performance
DIAGNOSTICS/ANALYTICAL EQUIPMENT			
Gas Chromatography	Airflow Sensors	Regulate the flow rate to eliminate outgassing	reliable, reduces risk of contamination, accurate, stable, easy to implement
	Pressure Sensors – Board Mount	Sense/control gas stream pressure to maintain a precise flow	accurate, stable
Blood Analyzers	Magnetoresistive Position Sensor ICs	Sense position of rotating blood samples and extraction needles	small, low Gauss operation, versatile
	Pressure Sensors – Board Mount	Regulate pump system pressure to draw and transport the samples	accurate, reliable, stable, repeatable, contaminant and corrosion resistant, product availability
	Thermistor Sensing Elements	Monitor chamber, lamps, and motor temperature to prevent overheating	flexible, cost-effective, small
PATIENT MONITORING SYSTEMS			
Respiratory Monitoring	Airflow Sensors	Monitor patient's respiratory function	accurate, customizable, stable, low pressure drop, saves time and money
Blood Glucose Monitoring	Pressure Sensors – Board Mount	Control the pumps used to draw the blood and return it to the patient so that the pressure does not rupture the veins	improves patient safety with enhanced stability and low drift, portable, accurate
Blood Pressure Monitoring	Pressure Sensors – Board Mount	Measure blood pressure	stable, accurate
Temperature Monitoring	Thermistor Sensing Elements	Monitor patient temperature	flexible, cost-effective, small
HOSPITAL HARDWARE			
Medication Dispensing Cabinets	Hall-effect Position Sensor ICs	Enable remote locking and unlocking of medication dispensing cabinet drawers	allows for enhanced security, minimizes medication dispensing errors, reliable, cost-effective, energy-efficient, size reduction, on-time delivery
Infant and Laboratory Incubators	Humidity Sensors	Monitor the incubator system to maintain humidification level in the chamber with accurate dew-point and humidity measurement	stable, reliable, allows application flexibility, cost-effective, durable
	Thermistor Sensing Elements	Monitor temperature	flexible, cost effective, small
Blood Pressure Monitors	Pressure Sensors – Board Mount	Measure blood pressure	portable, stable, accurate
Hospital Beds	MICRO SWITCH Basic Switches	Determine minimum/maximum position of electrically adjustable beds	accurate, repeatable, durable, effective design, small, light weight
	Pressure Sensors – Board Mount	Measure air pressure and controls the inflation and deflation of the mattress air columns to prevent bedridden patients from developing bedsores	accurate, reliable, stable
Sterilizers, Autoclaves, and Blood Refrigerators	Thermistor Sensing Elements	Monitor temperature	application flexibility, cost effective, small
SURGICAL INSTRUMENTS			
Surgical Fluid Management Systems	Force Sensors	Can help regulate the pressure at the pump head of a fluid management system, and as a back-up safety device to the direct pressure measurement at the joint	rugged design, stable, reliable, portable, and energy-efficient
	Pressure Sensors – Board Mount	Sense pressure directly at the joint site during arthroscopic surgery	accurate, improves patient safety
DENTAL EQUIPMENT			
Dental Chairs and Dental Imaging	Hall-effect Position Sensor ICs	Provide accurate motion control and positioning of the dental imaging system	accurate, energy-efficient, fast response, reliable
	MICRO SWITCH Watertight Miniature Switches	Provide dental chair foot pedal control	customizable, reliable
Pressure-Operated Dental Instruments	Pressure Sensors – Board Mount	Keep the water flow constant and at an adjusted level, allowing smooth operation of dental instruments	accurate, reliable, stable, water-resistant, contaminant-resistant



Table of Contents

Respiratory

- Anesthesia Delivery Systems 4**
 - Airflow Sensors
 - Hall-effect Position Sensor ICs
 - Humidity Sensors
 - Pressure Sensors and Transducers
 - Thermistor Sensing Elements
 - Packaged Temperature Probes
- Oxygen Concentrators 8**
 - Airflow Sensors
 - Pressure Sensors and Transducers
 - Pressure Switches
- Sleep Apnea Machines 10**
 - Airflow Sensors
 - Hall-effect Position Sensor ICs
 - Humidity Sensors
 - Pressure Sensors and Transducers
 - Thermistor Sensing Elements, Packaged Temperature Probes
 - Commercial Thermostats
- Ventilators 14**
 - Airflow Sensors
 - Hall-effect Position Sensor ICs
 - Humidity Sensors
 - Pressure Sensors and Transducers
 - Thermistor Sensing Elements
 - Packaged Temperature Probes
- Kidney Dialysis Machines 18**
 - Force Sensors
 - Hall-effect Position Sensor ICs
 - Pressure Sensors and Transducers
 - Thermistor Sensing Elements

- Infusion, Insulin, and Syringe Pumps 22**
 - Force Sensors
 - Magnetic Position Sensor ICs
 - Pressure Sensors
 - 2D Scan Engines
- Diagnostic/Analytical Equipment 25**
 - Airflow Sensors
 - Magnetoresistive Position Sensor ICs
 - Pressure Sensors
 - Thermistor Sensing Elements
- Patient Monitoring Systems 28**
 - Airflow Sensors
 - Pressure Sensors
 - Thermistor Sensing Elements
- Hospital Hardware 30**
 - Hall-effect Position Sensors ICs
 - Humidity Sensors
 - Thermistor Sensing Elements
 - MICRO SWITCH Basic Switches
 - Pressure Sensors
- Surgical Instruments 33**
 - Force Sensors
 - Pressure Sensors
- Dental Equipment 35**
 - Hall-effect Position Sensor ICs
 - MICRO SWITCH Watertight Miniature Switches
 - Pressure Sensors



For innovation that's well apart, there's only Honeywell Sensing and Internet of Things.

With more than 50,000 products ranging from snap-action, limit, toggle, and pressure switches to position, speed, pressure, and airflow sensors, Honeywell Sensing and Internet of Things (SIOT) has one of the broadest sensing and switching portfolios available.

Honeywell sensor, switch, and control components are tailored to exact specifications for stronger performance, longer productivity, and increased safety. Enhanced accuracy and durability are built into every part, improving output and endurance. For our customers, this can reduce expenditures and operational costs. Our global footprint and channels help to competitively price such components for your chosen application and provide immediate technical support.

Our expertise in medical, aerospace and defense, transportation, and industrial industries means we offer products and solutions for a wide range of applications. But, an impressive product line is only one part. We possess unique engineering expertise and value-added capabilities.

While Honeywell's switch and sensor solutions are suitable for a wide array of basic and complex applications, our custom-engineered solutions offer enhanced precision, repeatability, and ruggedness. We offer domain knowledge and technology resources, along with a close working relationship, to develop and deliver cost-effective, individually tailored solutions. Whether clean-slate development or simple modifications to an existing design are needed, our expertly engineered solutions help to meet the most stringent requirements with world-class product designs, technology integration, and customer-specific manufacturing.

With a 75-year legacy in the switch and sensor business, Honeywell SIOT has earned a reputation for reliability and excellence. Our strong product designs, Six Sigma Plus manufacturing environment, and robust testing facilities help provide quality out-of-the-box, as well as enhanced, sustainable performance down the line.

Global service, sourcing, and manufacturing. Industry-leading engineers. Value-added assemblies and solutions. Construction to required specifications. A one-stop, full-service, globally competitive supplier... Honeywell Sensing and Internet of Things.



Respiratory

Honeywell is a leading sensor provider for many potential respiratory applications due to delivering the lowest pressure drop in the industry while providing enhanced sensitivity, accuracy, reliability, and stability with minimal drift over time. Honeywell's sensors and switches can be used in a variety of potential respiratory applications, including anesthesia delivery systems, oxygen concentrators, sleep apnea machines, and ventilators.

Respiratory: Anesthesia Delivery Systems

An anesthesia machine is designed to deliver drugs to patients to help eliminate pain and other unwanted sensations. The continuous flow anesthetic machine provides an accurate and constant supply of medical gases (such as air, oxygen, and nitrous oxide), mixed with an accurate concentration of anesthetic vapor (such as isoflurane), and delivers this mixture to the patient at a desired pressure and flow.

Sensor Solutions for Anesthesia Delivery Systems

- | | |
|------------------------------------|---|
| Airflow Sensors | Pressure Sensors and Transducers |
| Thermistor Sensing Elements | Humidity Sensors |
| Packaged Temperature Probes | Hall-effect Position Sensor ICs |

Anesthesia Delivery Machine Block Diagram

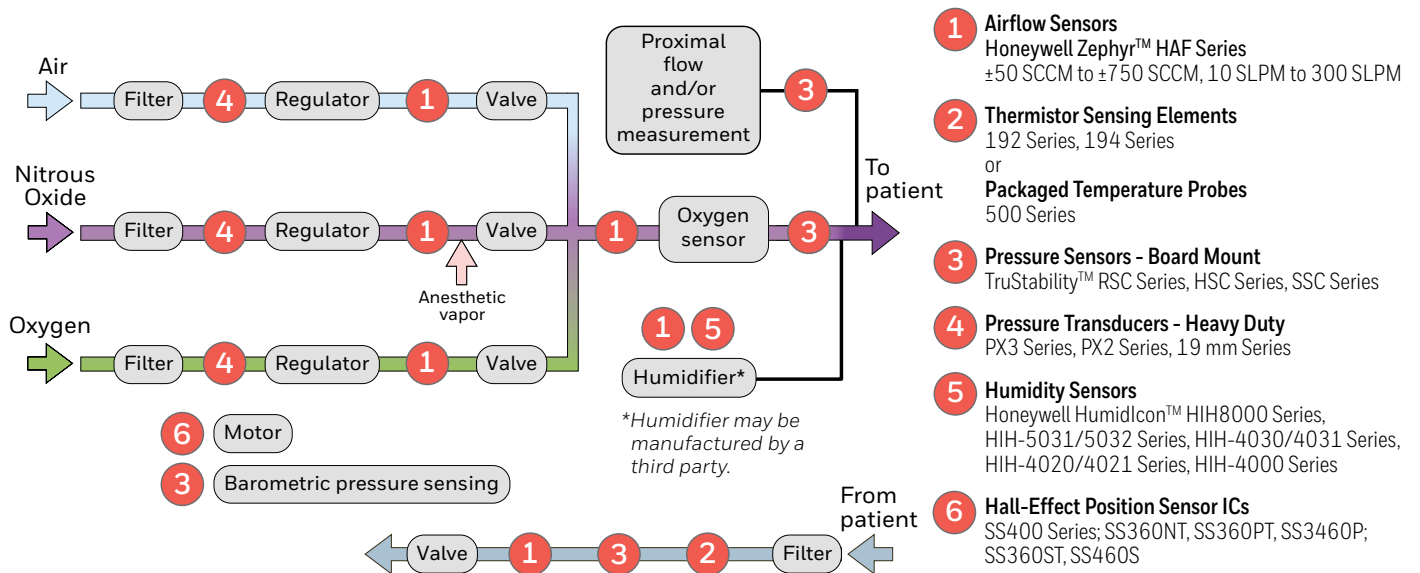

Airflow Sensors in Anesthesia Delivery Systems

Honeywell Zephyr™ HAF Series

Zephyr Airflow Sensors are designed to measure the flow of air, oxygen, and nitrous oxide. They may be used so that the desired mixture, as set by the doctor, is delivered to the patient.

Benefits to Customer

- **High 2.5% accuracy:** Allows for very precise airflow measurement, often ideal for demanding applications with high accuracy requirements
- **Customizable:** Allows the sensor to be designed to meet specific end-user needs
- **High sensitivity at very low flows:** Allows the customer's application to detect presence or absence of airflow
- **High stability:** Reduces errors due to thermal effects and null shift to provide accurate readings over time, often eliminating need for system calibration after printed circuit board (PCB) mount and periodically over time
- **Low pressure drop:** Low pressure drop typically improves patient comfort in medical applications, and reduces noise and system wear in components such as motors and pumps
- **Saves customers time and money:** Linear output provides a more intuitive sensor signal than the raw output of basic airflow sensors, often eliminating the need for customers having to linearize the output, helping to reduce production and design costs and implementation time

Thermistor Sensing Elements and Packaged Temperature Probes in Anesthesia Delivery Systems

Air from anesthesia machines that is warm and moist helps to provide the patient with a comfortable breathing situation and may reduce sore throats caused by breathing cold, dry air. As such, the temperature of the air delivery system is often monitored and controlled to provide an air stream at a desired level of warmth. Thermistor sensing elements are installed directly into the air stream and are designed to monitor the air temperature. The sensor is coupled to a microcontroller designed to measure air stream temperature and interact with the controller that regulates the temperature of the air stream. Honeywell offers several types of configurations. The packaged sensors are available as discrete components for customer-built assemblies, or Honeywell can provide a full assembly solution that the customer may simply pigtail into the system

Benefits to Customer

192 Series, 194 Series Thermistor Sensing Elements

- **Cost-effective:** Resistance temperature curve interchangeability designed to offer standardization of circuit components and simplification of design/replacement enhances cost-effectiveness
- **Flexible:** Bare leads (192 Series) or insulated leads (194 Series) are designed to provide application flexibility
- **Small:** Small size often eases use in confined spaces

500 Series Packaged Temperature Probes

- **Accurate:** Directs thermal or fluid flow evenly across thermistor sensing elements for accurate temperature sensing
- **Effective design:** Protects the thermistors against damage in use or handling
- **Flexible:** Wide operating temperature range of 60°C to 300°C [-76°F to 572°F] and wide selection of housing, resistance, and termination options provide application flexibility. Housing material ranges from all plastic to all metal, and accommodates air/gas, fluid immersion, or surface sensing requirements



HAF Series - Low Flow



HAF Series - High Flow



192 Series, 194 Series



500 Series

Pressure Sensors and Transducers in Anesthesia Delivery Systems

Board Mount Pressure Sensors: TruStability™ RSC Series, HSC Series, SSC Series

Heavy Duty Pressure Transducers: PX3 Series, 19 mm Series, SPT Series

Honeywell's TruStability board mount pressure sensors are designed to measure air and oxygen pressure so that the pressure doesn't exceed a desired level. The PX3 Series and 19 mm Series heavy duty pressure transducers are designed to provide a sensing solution when high pressure, steel pressure port interface and/or corrosive media are used. A male threaded pressure port and stainless steel wetted surfaces provide an air and oxygen inlet.

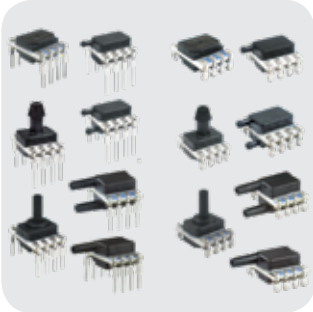

TruStability RSC Series



TruStability HSC Series,
SSC Series



PX3 Series



PX2 Series



13 mm Series, 19 mm Series



SPT Series

Benefits to Customer

- **Accurate:** Enhances patient safety by measuring gas volume and mixture to deliver the mixture at a desired pressure and flow
 - TruStability sensors' exceptional accuracy is a result of leading-edge technology, precise manufacturing processes, and temperature compensation and calibration. The RSC is ± 0.1 %FSS BFLS and the HSC and SSC are ± 0.25 %FSS BFLS
 - PX3, PX2, and 19 mm accuracy depends upon the pressure range: PX3 Series is ± 1.0 %FSS from -20°C to 85°C [-4°F to 185°F], PX2 Series Total Error Band is ± 2.0 %FSS
- **Compatible:** Wetted materials or media-isolated packaging (materials resistant to certain contaminants or media) offer compatibility with many harsh environments and resistance to certain contaminants
- **Easy to design in:** Customization of desired pressure ranges, connections, calibration, and temperature compensation minimizes design-in effort
- **Easy to use:** Small package with integrated signal conditioning reduces the number of components needed to implement the sensor, enabling size reduction of the end product
- **Safe:** Enhanced accuracy, sensitivity, and stability with minimal drift over time and temperature enhances patient safety and therapy effectiveness by sensing when patients are breathing on their own and are ready to wean off the device
- **Stable:** Stability is a measure of how little the output signal of the pressure sensor will change from measurement to measurement. The long-term stability of Honeywell's TruStability sensors is the best in the industry

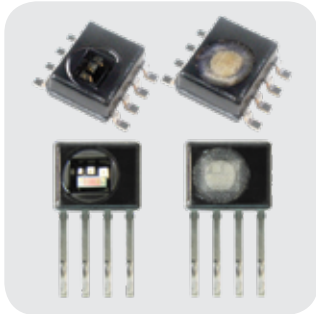

Honeywell HumidIcon™
HIH8000 Series

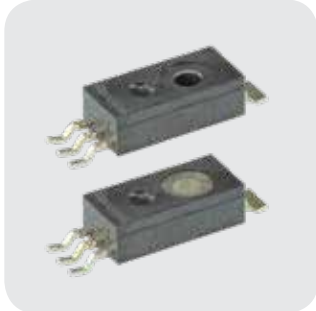

HIH-4030/4031 Series,
HIH-5030/5031 Series



HIH-4020/4021 Series



HIH-4000 Series

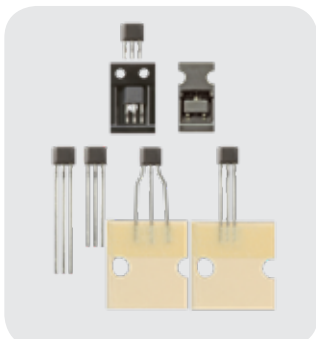

SS400 Series; SS360NT,
SS360ST, SS460S; SS360PT,
SS3460P

Humidity Sensors in Anesthesia Delivery Systems

Honeywell HumidIcon™ HIH8000 Series, HIH-4030/4031 Series, HIH-5030/5031 Series, HIH-4020/4021, HIH-4000 Series

These sensors may be used to deliver warm and moist air, which often enhances patient comfort. When introducing moisture into the air stream, it must be monitored and controlled. Honeywell's humidity sensors are installed either directly into the air stream or in a parallel branch. The sensor is coupled to a microcontroller designed to measure the humidity of the air stream and to interact with the controller that ensures the correct level of moisture is present.

Benefits to Customer

- **Industry-leading long term stability (1.2 RH% over 5 years):** Minimizes system performance issues, helps support system uptime, and eliminates the need to recalibrate the sensor in the application (HumidIcon)
- **Industry-leading Total Error Band (TEB) (± 5 %RH):** Provides the sensor's true accuracy reducing manufacturing time, supports system warranty requirements, helps optimize system uptime, and provides excellent sensor interchangeability (HumidIcon)
- **Lowest total cost solution:** Offers customers the lowest total cost solution due to the sensor's industry-leading Total Error Band and being a combined humidity/temperature sensor (HumidIcon)
- **Accurate:** Enhanced stability, accuracy, and response time over the entire humidity range of %RH to 100 %RH supports demanding system performance requirements, even in many condensing environments
- **Cost-effective:** Surface mount device (SMD) packaging on tape and reel allows for use in automated, high-volume, lower-cost pick-and-place manufacturing

Hall-Effect Position Sensor ICs in Anesthesia Delivery Systems

SS400 Series; SS360NT, SS360ST, SS460S; SS360PT, SS3460P

These Hall-effect magnetic position sensor ICs are designed to provide enhanced output accuracy for smooth motor control that reduces noise and vibration in a variety of potential applications, including anesthesia machine motor assembly fan systems. Its small size often allows for design into many compact, automated, lower-cost assemblies. A thermally balanced integrated circuit that is accurate over a full temperature range is designed to provide proper fan functionality.

Benefits to Customer

- **Accurate:** Enhanced accuracy and linearity over an output span of 0V to 5V enables an extended sensing range
- **Circuit protection:** Reverse voltage/polarity protection provides circuit protection
- **Cost-effective:** Small sensor size can allow for compact designs and automated, lower-cost assemblies
- **Effective:** Thermally-balanced integrated circuit that is accurate over the full temperature range enhances proper fan function
- **Energy-efficient:** Low power consumption enhances energy efficiency
- **Quiet:** Industry-leading sensor output accuracy for smooth motor control enables low audible noise and reduces motor vibration



Respiratory: Oxygen Concentrators

An oxygen concentrator reduces the amount of nitrogen in the air, increasing the oxygen level delivered to the patient. Oxygen concentrators are used with patients, such as those with lung disease, who have difficulty absorbing oxygen into the blood stream.

Sensor and Switch Solutions for Oxygen Concentrators

Pressure Sensors and Transducers

Airflow Sensors

Pressure Switches

Oxygen Concentrator Block Diagram

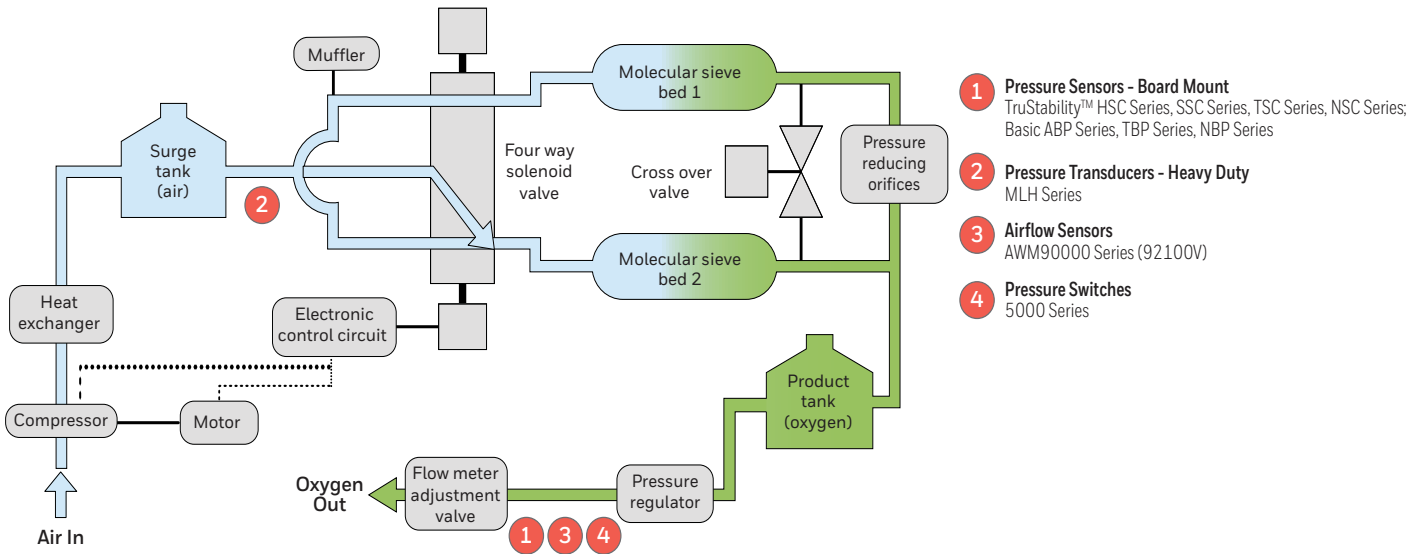

- 1 Pressure Sensors - Board Mount**
TruStability™ HSC Series, SSC Series, TSC Series, NSC Series;
Basic ABP Series, TBP Series, NBP Series
- 2 Pressure Transducers - Heavy Duty**
MLH Series
- 3 Airflow Sensors**
AWM90000 Series (921.00V)
- 4 Pressure Switches**
5000 Series



TruStability HSC Series,
SSC Series, TSC Series,
NSC Series



Basic ABP Series

Pressure Sensors and Transducers in Oxygen Concentrators

Board Mount Pressure Sensors: TruStability™ HSC, SSC, TSC, NSC Series; Basic ABP, TBP, NBP Series; Heavy Duty Pressure Transducers: MLH Series

Board mount pressure sensors may be used to detect when the patient begins to inhale so that oxygen can then be delivered efficiently and effectively. Not only can this enhance system response time, it can also minimize oxygen waste when the patient isn't inhaling, allowing the oxygen concentrator to be smaller and to operate more efficiently. Smaller equipment size also means lower power consumption, as well as greater portability. The MLH Series senses pressure from the surge tank, providing feedback to the compressor which allows the compressor to maintain the desired pressure level.

Benefits to Customer

- **Accurate and sensitive:** Provides an enhanced level of sensitivity and accuracy over the entire range. TruStability sensors' exceptional accuracy is a result of leading-edge technology, precise manufacturing processes, and temperature compensation and calibration. The Total Error Band of the HSC Series and SSC Series depends on pressure range, with the HSC Series as low as $\pm 1\%$ FSS and the SSC Series as low as $\pm 2\%$ FSS, better than most competitive products
- **Cost-effective:** Basic ABP Series, TBP Series, and NBP Series provide a cost-effective pressure sensing solution with a variety of options that allow customers to meet their specific application needs



Basic TBP Series, NPB Series

- **Efficient:** MLH Series allows the user to monitor pressure within the specified range and adjust as needed, enhancing oxygen efficacy
- **Reliable:** Provide enhanced quality and reliability
- **Stable:** Stability is a measure of how little the output signal of the pressure sensor will change from measurement to measurement. The long-term stability of Honeywell's TruStability sensors is the best in the industry

Airflow Sensors in Oxygen Concentrators

AWM90000 Series (AWM92100V)

Honeywell's airflow sensor for oxygen concentrators is designed to detect ultra-low flow levels at 0.1 cm³. This enhanced sensitivity may be used to detect when the patient exhales and when the system should reduce airflow, easing exhalation and improving patient comfort. Honeywell's airflow sensors deliver a low pressure drop (down to 0.2 cmH₂O at 200 SLPM), leading to lower flow resistance and improved patient comfort.

Benefits to Customer

- **Eases patient's breathing:** Delivers the lowest pressure drop in the industry (to 0.2 cmH₂O at 200 SLPM), providing lower flow resistance, which eases breathing
- **Improves patient's comfort:** Enhanced sensitivity (the ability to detect ultra-low flow levels at 0.1 cm³) allows the sensor to detect when the patient exhales, sending a signal to reduce airflow, which eases the patient's exhalation and improves patient comfort
- **Portable:** Small sensor package size allows system size reduction, increasing portability, which can improve a patient's quality of life
- **Quiet:** Lower blower motor resistance allows for a quieter operation, improving the patient's ability to sleep
- **Reliable:** Enhanced quality and reliability (<100 ppm) can reduce downtime in many demanding operations



MLH Series Series

Pressure Switches in Oxygen Concentrators

5000 Series

Honeywell's 5000 Series pressure switch is often located on the output of the oxygen concentrator's pressure regulator to alert the user by activating an indicator light if the pressure exceeds a specified limit. In some cases, it may also shut down the motor. Honeywell's pressure switch products have enhanced reliability and accuracy with fast transfer times (5 ms).

Benefits to Customer

- **Accurate:** "Off the shelf" catalog pressure switch accurately monitors pressure level
- **Extended life:** Rated at a 1 million cycle life allows for extended life of the product
- **One-stop shopping:** Select from a family of applicable Honeywell products
- **Reliable:** Reliable and repeatable set point minimizes costly repairs from over pressure



AWM90000 Series



5000 Series



Respiratory: Sleep Apnea Machines

Sleep apnea is the repeated cessation of breathing during sleep, sometimes hundreds of times during the night and often for a minute or longer. If left untreated, sleep apnea may cause high blood pressure, cardiovascular disease, memory, and weight problems. The resulting lack of restful sleep may also be responsible for job impairment and motor vehicle accidents.

A main treatment option is the use of a Positive Airway Pressure (PAP) machine. The patient wears a mask that uses pressure to send air flowing through the nasal passages so they don't collapse and cause breathing to cease. There are three main categories of PAPs (in order of complexity/cost):

- **CPAP (Continuous Positive Airway Pressure)** provides a constant pressure to the patient. This positive pressure keeps the throat from collapsing during sleep and allows the patient to breathe freely without worry of episodes of non-breathing.
- **Auto-PAP (Automatic Positive Airway Pressure)** measures the resistance in a patient's breathing. The amount of continuous pressure delivered to the patient is then automatically tuned to the minimum required to maintain an unobstructed airway on a breath-by-breath basis.
- **Bilevel-PAP (Bilevel Positive Airway Pressure)** provides two levels of pressure: IPAP (Inspiratory Positive Airway Pressure) and a lower EPAP (Expiratory Positive Airway Pressure).

Sensor Solutions for Sleep Apnea Machines

Airflow Sensors	Thermistor Sensing Elements
Humidity Sensors	Packaged Temperature Probes
Pressure Sensors	Commercial Thermostats
	Hall-effect Position Sensor ICs

Sleep Apnea Machine Block Diagram

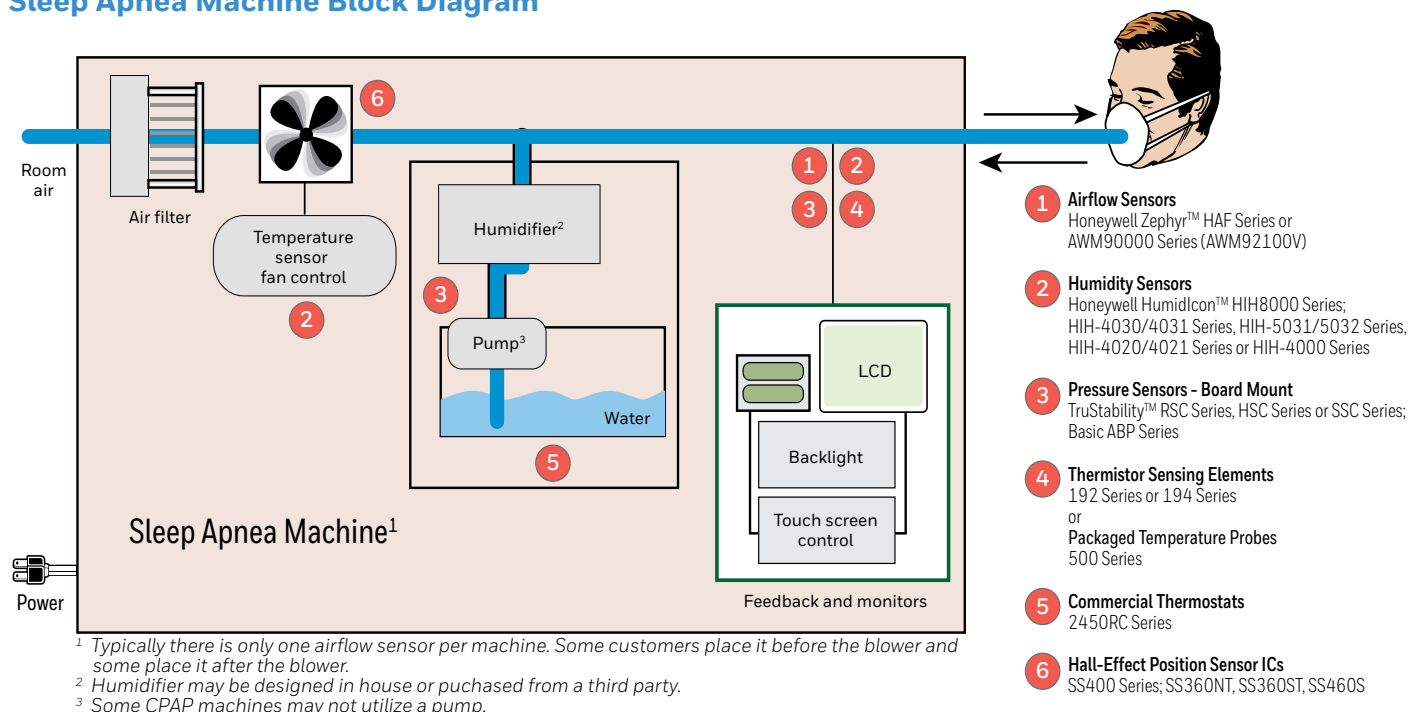

Airflow Sensors in Sleep Apnea Machines

Honeywell Zephyr™ HAF Series; AWM90000 Series (AWM92100V)

Honeywell's airflow sensors monitor the patient's breathing and send an output that alerts the machine to reduce its internal blower fan when the patient starts to exhale. The resulting lowered resistance prevents the patient from feeling as though he is "fighting" against the machine when breathing, reducing discomfort. Patients often find that machines that use an airflow sensor to detect the breathing cycle tend to be more comfortable, and are more likely to use such machines more regularly than equipment without this feature. Some insurance companies and doctors often prefer this equipment due to greater patient compliance. These sensors have been used in Auto-PAP and Bilevel-PAP machines.

Benefits to Customer

- **Meets high accuracy specifications:** High 2.5% accuracy allows for very precise airflow measurement, often ideal for demanding applications with high accuracy requirements (Zephyr)
- **Eases patient's breathing:** Delivers the lowest pressure drop in the industry (to 0.2 cmH₂O at 200 SLPM), providing lower flow resistance which eases breathing.
- **Improves patient's comfort:** Enhanced sensitivity (the ability to detect ultra-low flow levels at 0.1 cm³) allows the sensor to detect when the patient exhales, sending a signal to reduce airflow which eases the patient's exhalation and improves patient comfort
- **Portable:** Small sensor package size allows system size reduction, increasing portability, which can improve a patient's quality of life
- **Quiet:** Lower blower motor resistance allows for a quieter operation, improving the patient's ability to sleep
- **Reliable:** Enhanced quality and reliability (<100 ppm) reduce downtime in many demanding operations

Humidity Sensors in Sleep Apnea Machines

Honeywell HumidIcon™ HIH8000 Series, HIH-4030/4031 Series, HIH-5030/5031 Series, HIH-4020/4021 Series, HIH-4000 Series

Humidity sensors monitor the amount of humidified air with accurate dew point and absolute humidity/moisture measurement to provide a desired amount of air moisture to the patient, enhancing patient comfort to help provide uninterrupted sleep. Used in all three types of PAP machines.

Benefits to Customer

- **Industry-leading long term stability (1.2 RH% over 5 years):** Minimizes system performance issues, helps support system uptime, and eliminates the need to recalibrate the sensor in the application (HumidIcon)
- **Industry-leading Total Error Band (TEB) (±5 %RH):** Provides the sensor's true accuracy reducing manufacturing time, supports system warranty requirements, helps optimize system uptime, and provides excellent sensor interchangeability (HumidIcon)
- **Lowest total cost solution:** Offers customers the lowest total cost solution due to the sensor's industry-leading Total Error Band and being a combined humidity/temperature sensor (HumidIcon)
- **Accurate:** Enhanced stability, accuracy, and response time over the entire humidity range of %RH to 100 %RH supports demanding system performance requirements, even in many condensing environments
- **Cost-effective:** Surface mount device (SMD) packaging on tape and reel allows for use in automated, high-volume, lower-cost, pick-and-place manufacturing



HAF Series - Low Flow



HAF Series - High Flow



AWM90000 Series

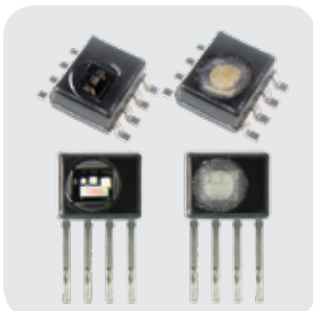

HumidIcon HIH8000 Series

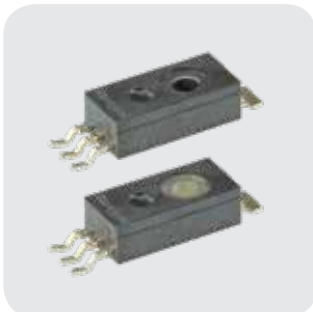

HIH-4030/4031 Series,
HIH-5030/5031 Series



HIH-4020/4021 Series

- **Durable:** Multi-layer construction and a hydrophobic filter provide enhanced resistance to condensation and contaminants
- **Flexible:** Its small, space-saving housing profile allows for application flexibility. Its low current draw allows for use in low-current-drain, battery-operated systems

Thermostats in Sleep Apnea Machines

2450RC Series

Bimetallic commercial thermostats may be included in sleep apnea machines as on-board (stand-alone) devices on flexible heaters for temperature control without the need to add associated software or electronics.

Benefits to Customer

- **Customizable:** Custom operating temperatures and tolerances fit customer-specific applications.
- **Flexible:** Wide variety of mounting brackets and terminals increase flexibility of use within the application.
- **Small:** Small product size often eases use in confined spaces.

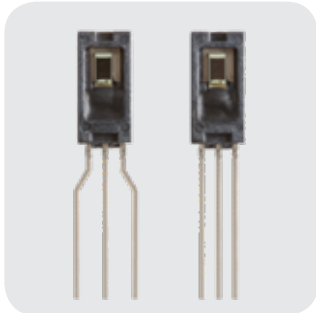

HIH-4000 Series

Thermistor Sensing Elements and Packaged Temperature Probes in Sleep Apnea Machines

192 Series, 194 Series, 500 Series

Air from sleep apnea machines that is warm and moist helps to provide the patient with a comfortable breathing situation and may reduce sore throats caused by breathing cold, dry air. As such, the temperature of the air delivery system is often monitored and controlled to provide an air stream at a desired level of warmth. Temperature sensors are installed directly into the air stream and are designed to monitor the air temperature.

Benefits to Customer

192 Series, 194 Series Thermistor Sensing Elements

- **Accurate and stable**
- **Cost-effective:** Resistance temperature matched interchangeable units designed to provide cost savings by eliminating the need for individual resistance temperature calibration and standardization of circuit components
- **Simple:** Designed to simplify design and replacement in temperature measurement, indication, control, and compensation of ambient temperature effects on a variety of integrated circuits and other semiconductor devices
- **Small:** Small size often eases use in confined spaces

500 Series Packaged Probes

- **Accurate:** Directs thermal or fluid flow evenly across thermistor sensing elements for accurate temperature sensing
- **Effective design:** Protects the thermistors against damage in use or handling
- **Flexible:** Wide operating temperature range [-60°C to 300°C [-76°F to 572°F]] and wide selection of housing, resistance, and termination options provide application flexibility. Housing material ranges from all plastic to all metal, and accommodates air/gas, fluid immersion, or surface sensing requirements



2450RC Series



192 Series and 194 Series



500 Series

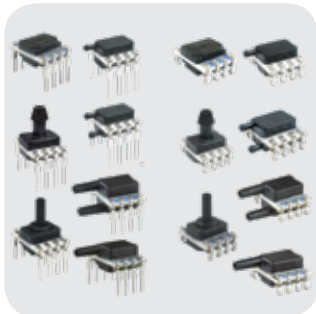

TruStability RSC Series



TruStability HSC Series,
SSC Series



Basic ABP Series

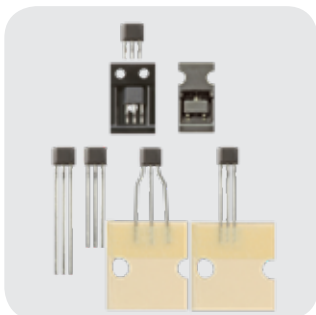

SS400 Series; SS360NT,
SS360ST, SS460S

Pressure Sensors in Sleep Apnea Machines

Board Mount Pressure Sensors: TruStability™ RSC Series, HSC Series, SSC Series; Basic ABP Series

Honeywell's TruStability board mount pressure sensors monitor the pressure of the air that is delivered to the patient in a variety of potential applications, including all three types of Positive Air Pressure (PAP) machines.

Benefits to Customer

- **Accurate:** TruStability sensors' exceptional accuracy is a result of leading-edge technology, precise manufacturing processes and temperature compensation and calibration. The RSC Series provides high 24-bit resolution and the Total Error Band after auto zero is as low as ± 0.25 %FSS. The Total Error Band of the HSC Series and SSC Series depends on the pressure range, with the HSC Series as low as ± 1 %FSS and the SSC Series as low as ± 2 %FSS.
- **Efficient:** The customer can monitor pressure within the specified range and adjust as needed, helping to prevent the airway from temporarily collapsing, improving the patient's ability to sleep and enhancing the efficacy of treatment.
- **Reliable:** Enhanced quality and reliability (<100 ppm) provides enhanced reliability in many demanding operations.
- **Sensitive:** Customized and calibrated to the customer's desired pressure range, providing enhanced sensitivity.
- **Stable:** Stability is a measure of how little the output signal of the pressure sensor will change from measurement to measurement. The long-term stability of Honeywell's TruStability sensors is the best in the industry.

Hall-Effect Position Sensor ICs in Sleep Apnea Machines

SS400 Series; SS360NT, SS360ST, SS460T

These Hall-effect position sensor ICs are designed to provide enhanced output accuracy for smooth motor control that reduces noise and vibration in potential applications that include sleep apnea machine motor assembly fan systems. Their small size allows for design into many compact, automated, lower-cost assemblies. A thermally-balanced integrated circuit that is accurate over a full temperature range is designed to provide proper fan functionality.

Benefits to Customer

- **Accurate:** Enhanced accuracy and linearity over and output span of 0 V to 5 V enables an extended sensing range
- **Circuit protection:** Reverse voltage and polarity protection provides circuit protection.
- **Cost-effective:** Small sensor size allows for compact designs and automated, lower-cost assemblies
- **Effective:** Thermally-balanced integrated circuit that is accurate over the full temperature range enhances proper fan function
- **Energy-efficient:** Low power consumption enhances energy efficiency
- **Quiet:** Industry-leading sensor output accuracy for smooth motor control enables low audible noise and reduces motor vibration



Respiratory: Ventilators

A ventilator is designed to move a mixture of air and oxygen into and out of a patient's lungs to either assist in breathing or, in some cases, do the mechanical breathing for a patient who is breathing insufficiently or is physically unable to breathe.

Sensor Solutions for Ventilators

Airflow Sensors
Thermistor Sensing Elements
Packaged Temperature Probes

Pressure Sensors and Transducers
Humidity Sensors
Hall-Effect Position Sensor ICs

Ventilator Block Diagram

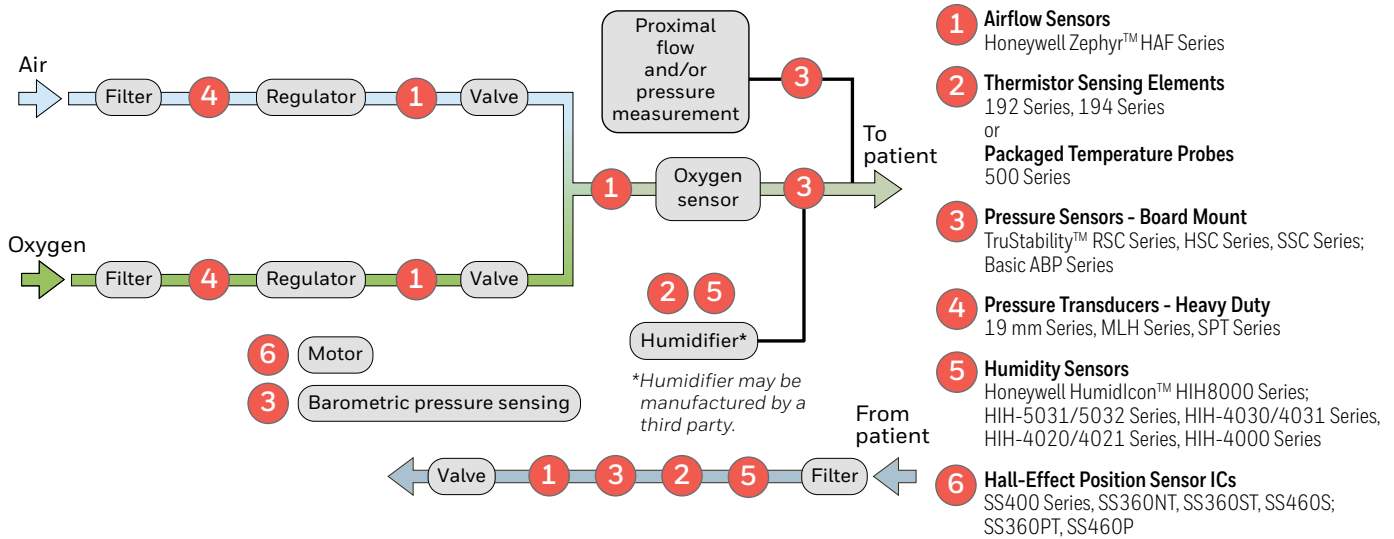

Zephyr HAF Series - Low Flow



HAF Series - High Flow

Airflow Sensors in Ventilators

Honeywell Zephyr™ HAF Series

Zephyr Airflow Sensors are designed to measure the flow of air, oxygen, and nitrous oxide. They may be used so that the desired mixture, as set by the doctor, is delivered to the patient. The total mixture that is delivered to the patient is also measured and is displayed on the ventilator panel.

Benefits to Customer

- **High 2.5% accuracy:** Allows for very precise airflow measurement, often ideal for demanding applications with high accuracy requirements.
- **Customizable:** Allows the sensor to be designed to meet specific end-user needs.
- **High sensitivity at very low flows:** Allows the customer's application to detect presence or absence of airflow.
- **High stability:** Reduces errors due to thermal effects and null shift to provide accurate readings over time, often eliminating need for system calibration after printed circuit board (PCB) mount and periodically over time.
- **Low pressure drop:** Low pressure drop typically improves patient comfort in medical applications, and reduces noise and system wear in components such as motors/pumps.
- **Saves customers time and money:** Linear output provides a more intuitive sensor signal than the raw output of basic airflow sensors, often eliminating the need for customers having to linearize the output which can help to reduce production and design costs and implementation time.



192 Series and 194 Series

Thermistor Sensing Elements in Ventilators

192 Series, 194 Series

Warm, moist air from ventilators helps to provide the patient with a comfortable breathing situation and may reduce sore throats caused by breathing cold, dry air. As such, the temperature of the air delivery system is often monitored and controlled to provide an air stream at a desired level of warmth. Thermistor sensing elements are installed directly into the air stream and are designed to monitor the air temperature. The sensor is coupled to a microcontroller designed to measure air stream temperature and interact with the controller which controls and regulates the temperature of the air stream. The packaged sensors are available as discrete components for customer-built assemblies, or Honeywell can provide a full assembly solution that the customer may simply pigtail into the system.



500 Series

Benefits to Customer

- **Cost-effective:** Resistance temperature curve interchangeability designed to offer standardization of circuit components and simplification of design/replacement enhances cost-effectiveness.
- **Flexible:** Bare leads (192 Series) or insulated leads (194 Series) are designed to provide application flexibility.
- **Small:** Small size often eases use in confined spaces.

Packaged Temperature Probes

500 Series

Packaged temperature probes perform the same function in this application as thermistor sensing elements (monitor air temperature).



TruStability RSC Series

Benefits to Customer:

- **Flexible:** Wide selection of housing, resistance, and termination options.
- **Customizable:** Variety of custom or off-the-shelf products available.

Pressure Sensors/Transducers in Ventilators

Board Mount Pressure Sensors: TruStability™ RSC, HSC Series, SSC Series, Heavy Duty Pressure Transducers: MLH Series, 19 mm Series, SPT Series

Honeywell's TruStability Series board mount pressure sensors are designed to measure air and oxygen pressure to ensure it does not exceed a desired level. The MLH Series, 19 mm Series, and SPT Series heavy duty pressure transducers are designed to provide a sensing solution when high pressure, steel pressure port interface, and/or corrosive media are used. A male threaded pressure port and stainless steel wetted surfaces provide an air and oxygen inlet.



TruStability HSC Series, SSC Series

Benefits to Customer

- **Accurate:** Enhances patient safety by measuring volume and mixture of gases to deliver the mixture at a desired pressure and flow:
 - TruStability sensors' exceptional accuracy is a result of leading-edge technology, precise manufacturing processes, and temperature compensation and calibration. The RSC Series provides high 24-bit resolution and the Total Error Band after auto zero is as low as ± 0.25 %FSS. The Total Error Band of the HSC Series and SSC Series depends on the pressure range, with the HSC Series as low as ± 1 %FSS and the SSC Series as low as ± 2 %FSS.
 - MLH Series' accuracy depends upon the pressure range: above 300 psi 0.25 %FSS; below 300 psi 0.5 %FSS; 19 mm Series offers 0.25 %FSS; SPT Series offers 0.25 %FSS.



MLH Series



19 mm Series



SPT Series

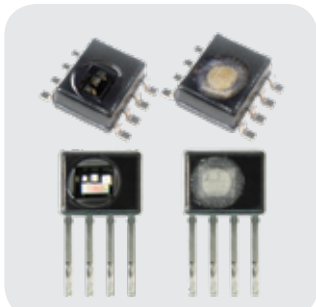

HumidIcon HIH8000 Series

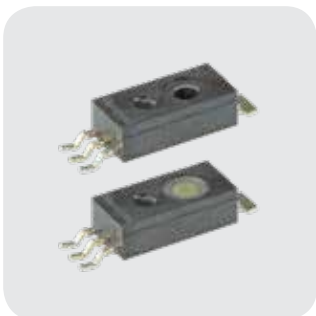

HIH-4030, HIH-4031 Series,
HIH-5030, HIH-5031 Series



HIH-4020/4021 Series

- **Compatible:** Wetted materials or media isolated packaging (materials resistant to certain contaminants or media) offer compatibility with many harsh environments and resistance to certain contaminants.
- **Easy to design in:** Customization of pressure ranges, connections, calibration, and temperature compensation minimize customer's design-in effort.
- **Easy to use:** Small package with integrated signal conditioning reduces the number of components needed to implement the sensor, enabling size reduction of the end product.
- **Safe:** Enhanced accuracy, sensitivity, and stability with minimal drift over time and temperature enhances patient safety and therapy effectiveness by sensing when patients are breathing on their own and are ready to wean off the device.
- **Stable:** Stability is a measure of how little the output signal of the pressure sensor will change from measurement to measurement. The long-term stability of Honeywell's TruStability sensors is the best in the industry.

Humidity Sensors in Ventilators

Honeywell HumidIcon™ HIH8000 Series, HIH-4030/4031 Series, HIH-5030/5031 Series, HIH-4020/4021 Series, HIH-4000 Series

Honeywell's humidity sensors help deliver warm and moist air, which often enhances patient comfort. When introducing moisture into the air stream of a ventilator, it must be monitored and controlled. Honeywell's humidity sensors are installed either directly into the air stream or in a parallel branch. The sensor is coupled to a microcontroller designed to measure the humidity of the air stream and to signal the controller that the desired level of moisture is present.

Benefits to Customer

- **Industry-leading long term stability (1.2 RH% over 5 years):** Minimizes system performance issues, helps support system uptime, and eliminates the need to recalibrate the sensor in the application (HumidIcon).
- **Industry-leading Total Error Band (TEB) ($\pm 5\%RH$):** Provides the sensor's true accuracy reducing manufacturing time, supports system warranty requirements, helps optimize system uptime, and provides excellent sensor interchangeability (HumidIcon).
- **Lowest total cost solution:** Offers customers the lowest total cost solution due to the sensor's industry-leading Total Error Band and being a combined humidity/temperature sensor (HumidIcon).
- **Accurate:** Enhanced stability, accuracy, and response time over the entire humidity range of 0 %RH to 100 %RH supports demanding system performance requirements, even in many condensing environments.
- **Cost-effective:** Surface mount device (SMD) packaging on tape and reel allows for use in automated, high-volume, lower-cost pick-and-place manufacturing.
- **Durable:** Multi-layer construction and a hydrophobic filter provides enhanced resistance to condensation and contaminants.
- **Flexible:** Small, space-saving housing profile allows for application flexibility; utilizing a low current draw allows for use in low-current-drain, battery-operated systems.

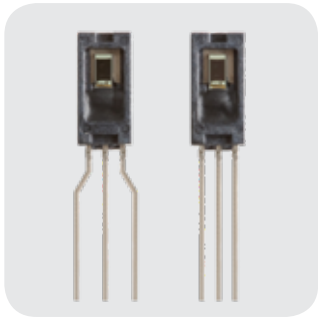

HIH-4000 Series

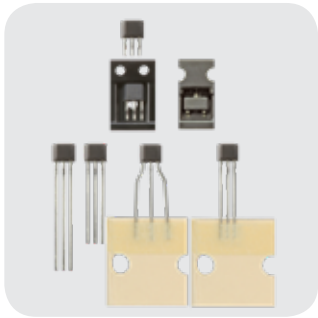

SS400 Series; SS360NT,
SS360ST, SS460S; SS360PT,
SS460P

Hall-Effect Position Sensor ICs in Ventilators

SS400 Series; SS360NT, SS360ST, SS460S; SS360PT, SS460P

These Hall-effect position sensor ICs are designed to provide enhanced output accuracy for smooth motor control that reduces noise and vibration in many potential applications, including ventilator motor assembly fan systems. Their small size often allows for design into many compact, automated, lower-cost assemblies. A thermally-balanced integrated circuit that is accurate over a full temperature range is designed to provide proper fan functionality.

Benefits to Customer

- **Accurate:** Enhanced accuracy and linearity over a 0 V to 5 V output span enables an extended sensing range.
- **Circuit protection:** Reverse voltage/polarity protection provides circuit protection.
- **Cost-effective:** Small sensor size allows for compact designs and automated, lower-cost assemblies.
- **Effective:** Thermally-balanced integrated circuit enhances proper fan function.
- **Energy-efficient:** Low power consumption enhances energy efficiency.
- **Quiet:** Industry-leading sensor output accuracy for smooth motor control enables low audible noise and reduces motor vibration.



Kidney Dialysis Machines

Kidney dialysis machine treatments replace some kidney functions by removing waste and fluid from the bloodstream via diffusion and osmosis of solutes and fluid across a semi-permeable dialysis membrane.

Blood in one compartment is pumped along one side of the membrane while a dialysate (a crystalloid solution that acts as a sponge for impurities) is pumped along the other side, in a separate compartment, in the opposite direction. ultra filtration occurs by increasing the hydrostatic pressure across the membrane by applying a negative pressure to the dialysate compartment of the dialyzer.

This pressure gradient causes water and dissolved solutes to move from the blood to the dialysate. The cleansed blood returns via the circuit back to the body. Honeywell manufactures many sensors that may be used in kidney dialysis machines. They provide presence and absence detection, and pressure, flow, and temperature measurement.

Sensor Solutions for Kidney Dialysis Machines

Pressure Sensors and Transducers
Hall-Effect Position Sensor ICs

Thermistor Sensing Elements
Force Sensors

Kidney Dialysis Machine Block Diagram

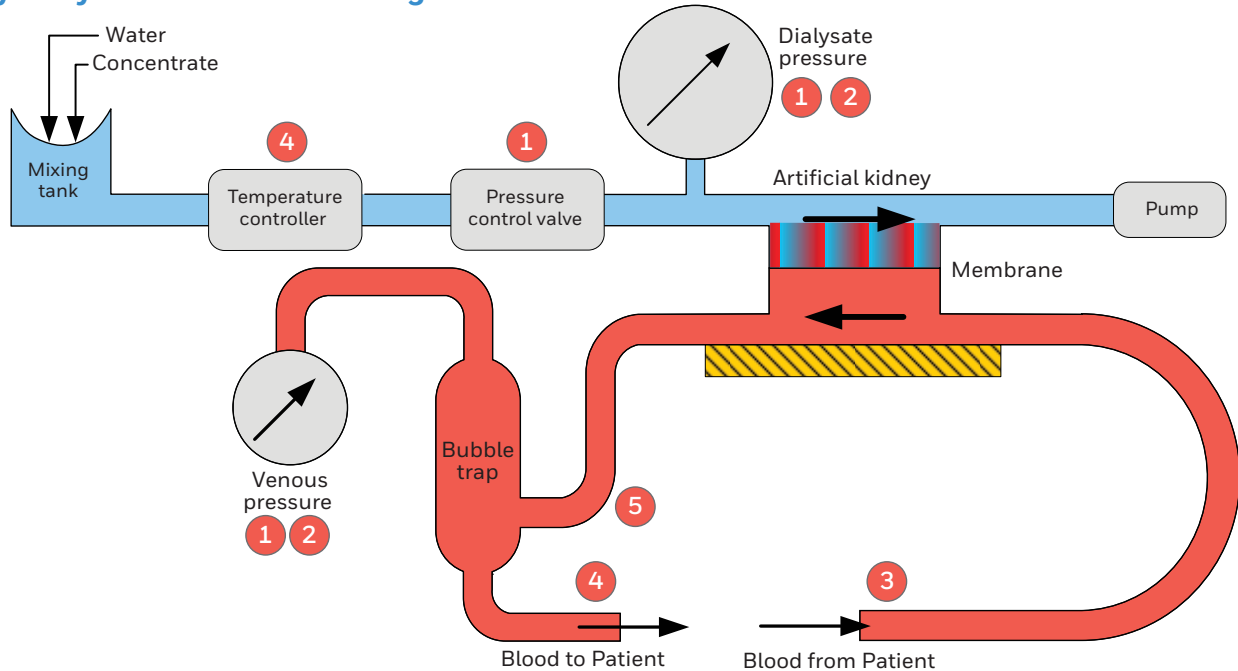

1 Pressure Sensors - Board Mount
TruStability™ RSC Series, HSC Series, SSC Series;
26PC Flow-Through Series

2 Pressure Transducers - Heavy Duty
13 mm Series, 19 mm Series, SPT Series

3 Hall-effect Position Sensor ICs
SS490 Series; SS360NT, SS360ST, SS460S

4 Thermistor Sensing Elements
192 Series, 194 Series

5 Force Sensors
FSA Series, TBF Series, 1865 Series

Dialysis Membrane Detail

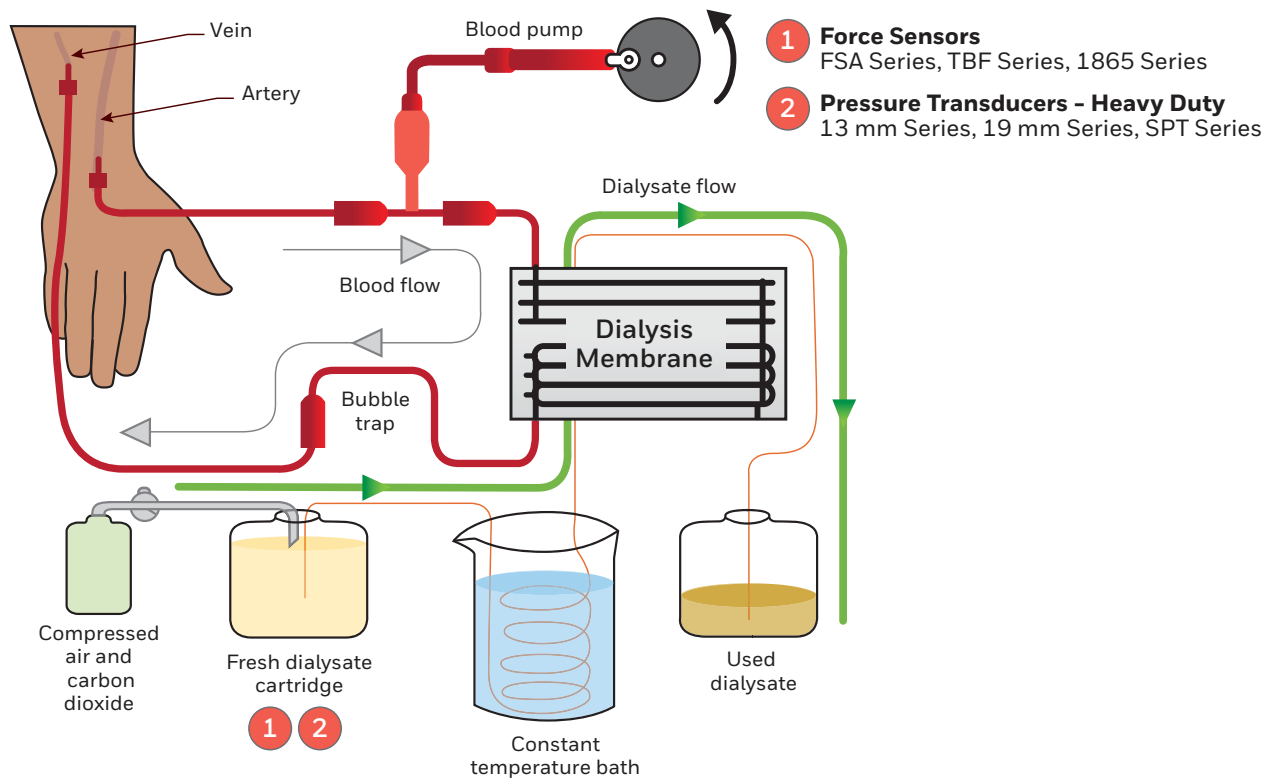

TruStability RSC Series



TruStability HSC Series,
SSC Series

Pressure Sensors and Transducers in Kidney Dialysis Machines

Board Mount Pressure Sensors: TruStability™ RSC Series, HSC Series, SSC Series; 26PC Flow-Through Series (26PCFEP5G40)

Heavy Duty Pressure Transducers: 13 mm Series, 19 mm Series, SPT Series

Honeywell's TruStability and 26PC Series flow-through board mount pressure sensors are designed to provide enhanced reliability and may be used to obtain a direct, in-line continuous dialysate and venous pressure measurement in the dialysis membrane without interrupting flow. The easy-to-sterilize package eliminates the need for an additional pressure tap and/or manifold, minimizing the unused space in the flow measurement path, which helps to prevent bacteria contamination and simplifies sterilization. The 13 mm Series, 19 mm Series, and SPT Series heavy duty pressure transducers, when located in a fresh dialysate cartridge, may be used to monitor pressure in the flexible tubing that carries blood or dialysate to provide continuous feedback of line pressures and pump control. These sensors may also be used to perform the same function as the 26PC Flow-Through Series in the dialysis membrane.

Benefits to Customer

- **Accurate:** Provides stable performance with low drift over time, allowing accurate pressure monitoring of fluid and blood flow to help maintain the pressure in the desired range, improving treatment efficiency and reducing the time it takes to remove fluid from the peritoneum.
 - TruStability sensors' exceptional accuracy is a result of leading-edge technology, precise manufacturing processes and temperature compensation and calibration. The RSC Series provides high 24-bit resolution and the Total Error Band after auto zero is as low as $\pm 0.25\%$ FSS. The Total Error Band of the HSC Series and SSC Series depends on the pressure range, with the HSC Series as low as $\pm 1\%$ FSS and the SSC Series as low as $\pm 2\%$ FSS.
 - The 26PC Flow-Through Series offers accuracy of $\pm 2\%$ FSS; the 13 mm Series, 19 mm Series, and SPT Series offer accuracy of 0.25% FSS.



26PC Flow-Through Series

- **Easy to design in:** Customization with desired pressure ranges, connections, calibration, and temperature compensation minimizes customer's design-in effort.
- **Extended life:** Product availability throughout the customer's product life cycle minimizes the need to repeat the design-in process and requalifying/resubmitting for regulatory approval.
- **Small:** Small package reduces the number of components needed to implement the sensor, enabling reduction in size and weight.
- **Stable:** Stability is a measure of how little the output signal of the pressure sensor will change from measurement to measurement. The long-term stability of Honeywell's TruStability sensors is the best in the industry.



13 mm Series, 19 mm Series

Hall-Effect Position Sensor ICs in Kidney Dialysis Machines SS490 Series; SS360NT, SS360ST, SS460S

Hall-effect position sensor ICs are designed to provide reliable, accurate output for smooth motor control that reduces noise and vibration in the machine's motor assembly and improves its efficiency. Their solid state reliability often reduces repair and maintenance costs, and its small size allows for design into many compact, automated, lower-cost assemblies. A thermally-balanced integrated circuit provides consistent operation over the full temperature range.

Benefits to Customer

- **Accurate:** For linear displacement and current sensing, analog Hall-effect sensors provide accurate and linear output, enabling an extended sensing range (SS490 Series).
- **Cost-effective:** Small sensor size allows for compact designs and automated, lower-cost assemblies and minimizes replacement costs.
- **Energy-efficient:** Hall-effect sensors consume little energy and help improve motor efficiency.
- **Quiet:** Reliable, accurate sensor output for smooth motor control enables low audible noise, and reduces motor vibration.



SPT Series

Thermistor Sensing Elements in Kidney Dialysis Machines 192 Series, 194 Series

Temperature directly affects the permeation rate across the dialysis membrane. The 192 Series and 194 Series thermistor sensing elements provide temperature measurement for enhanced control of this variable. The sensor is coupled to a microcontroller designed to monitor the temperature of the operation and to interact with the controller to help regulate the temperature of the system. Honeywell offers several configurations. These packaged sensors are available as discreet components for custom-built assemblies, as well as full assembly solutions that the customer may simply pigtail into the system.

Benefits to Customer

- **Cost-effective:** Resistance temperature curve interchangeability designed to offer standardization of circuit components and simplification of design/replacement enhances cost-effectiveness.
- **Flexible:** Bare leads (192 Series) or insulated leads (194 Series) are designed to provide application flexibility.
- **Small:** Small size often eases use in confined spaces.

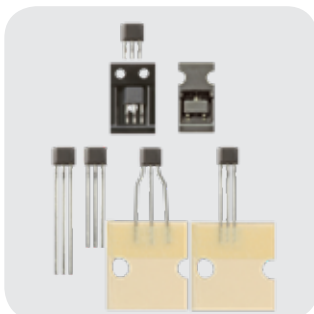

SS490 Series; SS360NT,
SS360ST, SS460S



192 Series, 194 Series

Force Sensors in Kidney Dialysis Machines

1865 Series, FSA Series, TBF Series

Honeywell's 1865 Series, FSA Series and TBF Series force sensors may be used to detect the presence or absence of a fresh dialysate cartridge before the dialysis machine can be used. These sensors are used in a non-invasive manner and require no disinfection or sterilization before reuse. Other potential uses for Honeywell's force sensors include monitoring the flexible tubing pressure of the dialysate to detect whether the pressure exceeds a specified level, and monitoring the weight of the dialysate to detect whether there is a sufficient amount of dialysate in the fresh dialysate cartridge.

Benefits to Customer

- **Reliable:** Enhanced quality and reliability (<100 ppm).
- **Sensitive:** Enhanced sensitivity to force changes enables early detection of occlusion, enhancing patient safety.
- **Stable:** Ability to detect occlusion accurately over time provides enhanced stability and low drift.



1865 Series

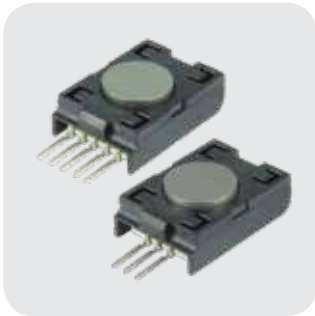

FSA Series

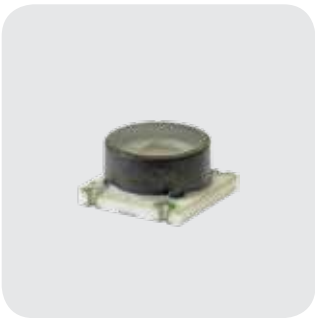

TBF Series



Infusion, Insulin, and Syringe Pumps

An infusion, insulin, or syringe pump—typically a screw pump that pushes on a syringe or cartridge—is used to deliver small amounts of medication to a patient intravenously.

Sensor Solutions for Anesthesia Delivery Systems

- Force Sensors
- Pressure Sensors
- Magnetic Position Sensor ICs
- 2D Scan Engines

Infusion Pump Block Diagram

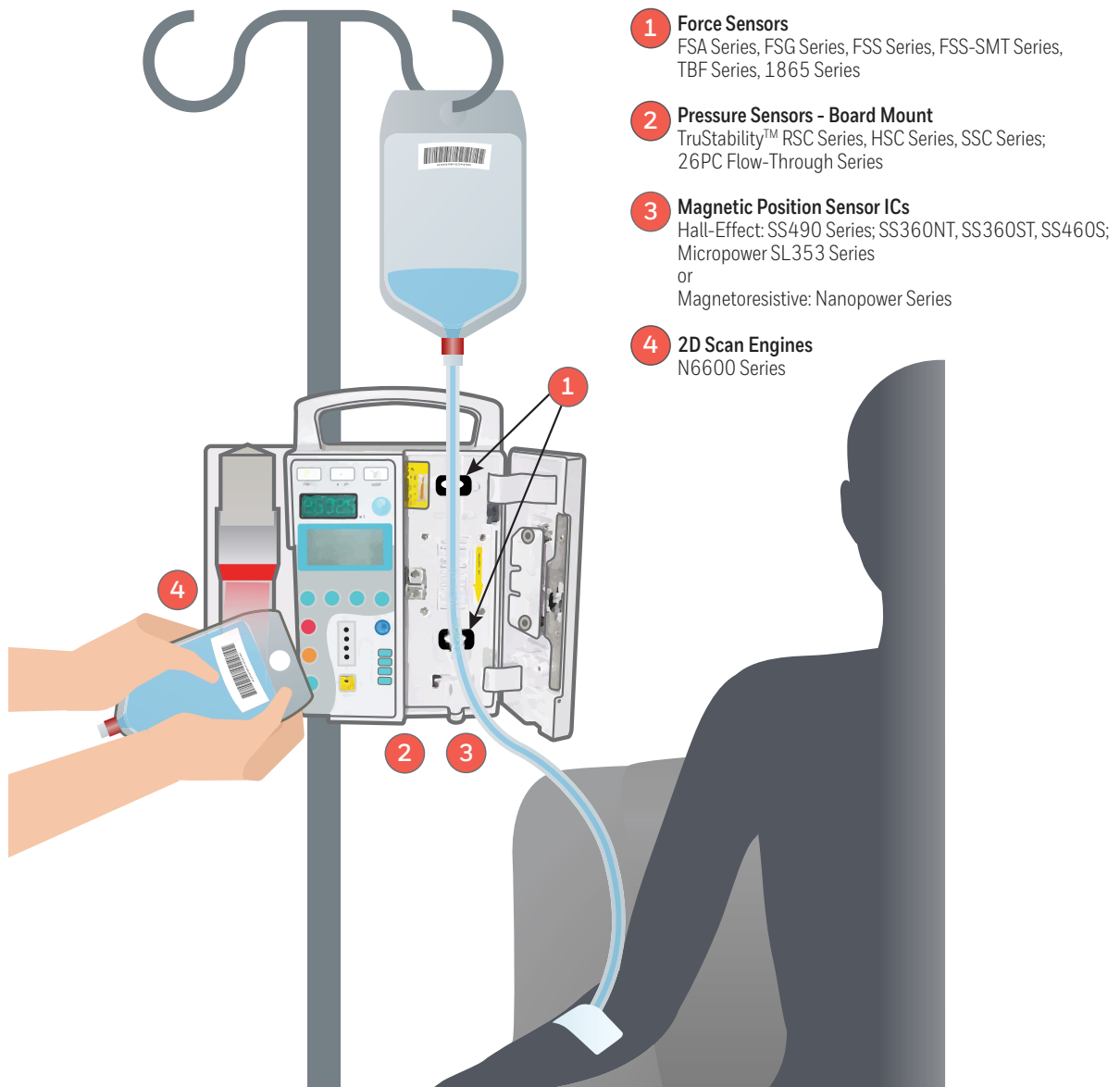

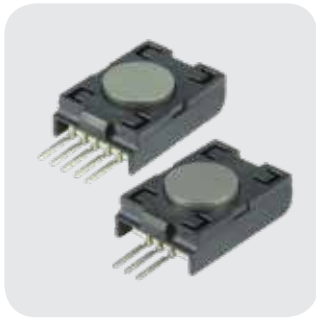

FSA Series



FSG Series



FSS Series, FSS-SMT Series



TBF Series



1865 Series

Force Sensors in Infusion, Insulin Pumps, and Syringe Pumps

FSA Series, FSG Series, FSS Series, FSS-SMT Series, TBF Series, 1865 Series

Honeywell's force sensors provide an occlusion detector to ensure there isn't a blockage in the infusion or insulin pump's tube that delivers the medication to the patient. If the tube becomes blocked, the force sensor alerts the patient, nurse, or doctor via an audible alarm that the therapy isn't being delivered.

Benefits to Customer

- **Easy to use:** The sensor is external to the tubing (media isolated), minimizing the need for the tubing to be sterilized or re-sterilized after each use.
- **Portable:** The sensor's small size and low power consumption improves the patient's quality of life due to the increased portability of the end product and longer battery life (FSS Series).
- **Reliable:** Enhanced quality and reliability (<100 ppm) provides enhanced reliability in many demanding operations.
- **Sensitive:** Enhanced sensitivity to force changes enables early detection of occlusion, enhancing patient safety.
- **Stable:** Ability to detect occlusion accurately over time provides enhanced stability and low drift.

Magnetic Position Sensor ICs in Infusion and Insulin Pumps

Hall-Effect: SS490 Series; SS360NT, SS360ST, SS460S; Micropower SL353 Series Magnetoresistive: Nanopower Series

These magnetic position sensors are designed to provide reliable, accurate output for smooth motor control that reduces noise and vibration in the pump's motor assembly and improves its efficiency. Its solid state reliability often reduces repair and maintenance costs, and its small size allows for design into many compact, automated, lower-cost assemblies. A thermally-balanced integrated circuit provides consistent operation over the full temperature range.

Benefits to Customer

- **Energy efficient:** Hall-effect sensors consume little energy and help improve motor efficiency. The Micropower SL353 Series' supply voltage (as low as 2.2 Vdc) combined with very low average current reduces power consumption and provides extended battery life.
- **Push-pull output does not require external pull-up resistor:** Simplifies interface with common electrical circuits and potentially reduces PC board space and costs to the customer (Micropower SL353 Series).
- **Non-chopper stabilized design:** Does not utilize chopper stabilization, eliminating noise generated by products using this technique (Micropower SL353 Series).
- **Accurate:** For linear displacement and current sensing, analog Hall-effect sensors provide accurate and linear output, enabling an extended sensing range (SS490 Series).
- **Cost-effective:** Small sensor size allows for compact designs and automated, lower-cost assemblies and minimizes replacement costs.
- **Quiet:** Reliable, accurate sensor output for smooth motor control enables low audible noise, and reduces motor vibration.

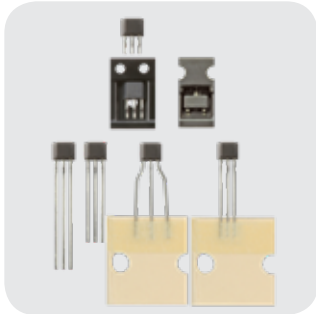

SS400 Series; SS360NT,
SS360ST, SS460S

Pressure Sensors in Infusion, Insulin, and Syringe Pumps

Board Mount Pressure Sensors: TruStability™ HSC Series, SSC Series

Honeywell's TruStability board mount pressure sensors may be used to monitor and control the fluid flow.

Benefits to Customer

- **Accurate:** Provides stable performance with low drift over time, allowing accurate pressure monitoring of fluid flow to help maintain the pressure in the desired range, improving treatment efficiency. TruStability sensors' exceptional accuracy is a result of leading-edge technology, precise manufacturing processes and temperature compensation and calibration. The Total Error Band of the HSC Series and SSC Series depends on the pressure range, with the HSC Series as low as $\pm 1\%$ FSS and the SSC Series as low as $\pm 2\%$ FSS, better than most competitive products.
- **Easy to design in:** Customization with desired pressure ranges, connections, calibration, and temperature compensation minimizes customer's design-in effort.
- **Stable:** Stability is a measure of how little the output signal of the pressure sensor will change from measurement to measurement. The long-term stability of Honeywell's TruStability sensors is the best in the industry.

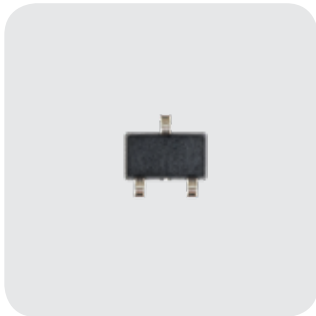

Nanopower Series,
Standard Power Series

2D Scan Engines in Infusion, Insulin, and Syringe Pumps

N6600 Series

Scan engines are designed to help provide barcode scanning ability, helping to verify treatment procedures as they are being delivered.

Benefits to Customer

- **Easy to design in:** The slimmest height in the industry at 6.8 mm [0.27 in]; available MIPI interface supports the latest technology trends for shorter design cycles
- **Optimized white illumination:** Simplifies reading barcodes; highly visible aimer provides a clear, sharp and easily observed target area
- **Enhanced scan performance:** Provides fast scan speed, ultra-fast motion tolerance up to 5 m/s, excellent reading capability for poorly-printed barcodes, and support for color barcodes and full symbology
- **Adaptus 6.0 imaging technology:** Quickly and accurately reads barcodes and OCR fonts with best-in-class range and enhanced motion tolerance, even hard-to-read codes and those on mobile phone screens



TruStability HSC Series,
SSC Series



N6600 Series



Diagnostics/Analytical Equipment

Blood analyzers using flow cytometry are used to examine microscopic cells and chromosomes by suspending them in a stream of fluid and passing them by an electronic detection apparatus in order to analyze their characteristics. Flow cytometry is often used to diagnose health disorders, such as blood cancers, as well as in research and clinical practice.

Sensor Solutions for Diagnostics/Analytical Equipment

Blood Analyzers

- Magnetoresistive Position Sensor ICs
- Pressure Sensors
- Thermistor Sensing Elements

Gas Chromatography

- Airflow Sensors
- Pressure Sensors

Blood Analyzer Block Diagram

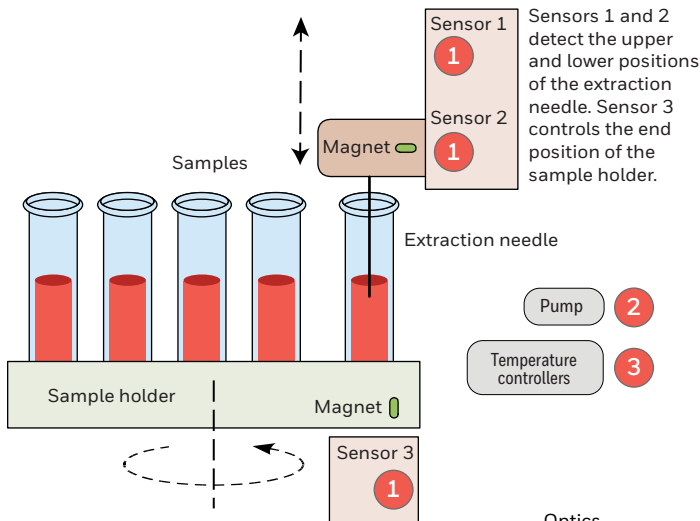

- 1 Magnetoresistive Position Sensor ICs
2SS52M Series
- 2 Pressure Sensors - Board Mount
TruStability™ RSC Series, HSC Series, SSC Series;
26PC Flow-Through Series
- 3 Thermistor Sensing Elements
192 Series, 194 Series

Flow Cytometry Block Diagram

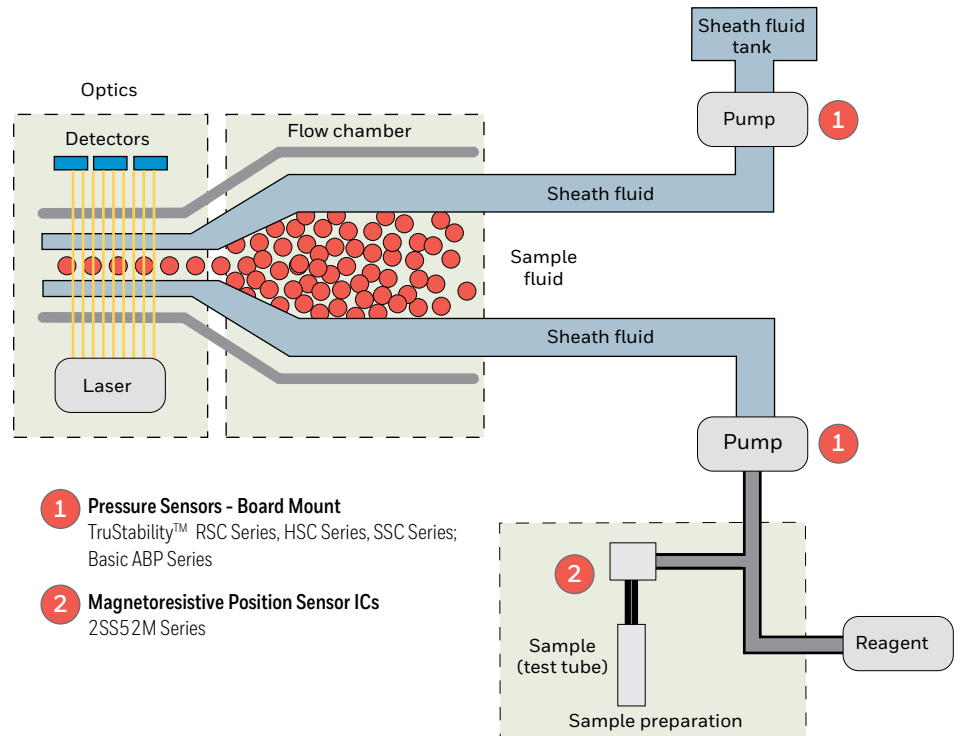

- 1 Pressure Sensors - Board Mount
TruStability™ RSC Series, HSC Series, SSC Series;
Basic ABP Series
- 2 Magnetoresistive Position Sensor ICs
2SS52M Series

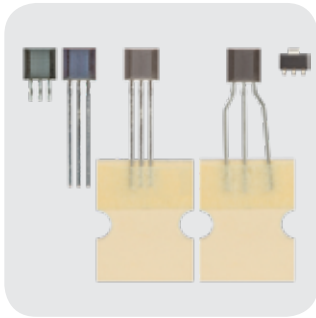

2SS52M Series

Magnetoresistive Position Sensor ICs

2SS52M Series

Blood analyzers may use a series of rotating blood probes from which an extraction needle or pipette removes samples. Equipment designers must find a reliable solution for sensing position in a non-contact, mechanical system. To control the automated mechanisms, a series of magnetoresistive position sensor ICs may be used to detect extraction needle movement.

Benefits to Customer

- **Small:** Simplifies mounting on the printed circuit board.
- **Low Gauss operation:** Can extend sensing distance to 25.4 mm [1 in] or more, depending on magnet strength.
- **Versatile:** Sensor can be activated with either a North or South magnetic pole; standard digital sinking output makes it easy to interface with most electronic circuits; accepts a wide supply voltage range of 3.8 V to 30 V, so it can use most available supply sources.



TruStability RSC Series

Pressure Sensors

Board Mount Pressure Sensors: TruStability™ RSC Series, HSC Series, SSC Series; Basic ABP Series; 26PC Series

Honeywell's TruStability and 26PC Series board mount pressure sensors are used to regulate the pressure in the pump system to draw and transport the blood samples.

Benefits to Customer

- **Accurate:** TruStability sensors' exceptional accuracy is a result of leading-edge technology, precise manufacturing processes, and temperature compensation and calibration. The RSC Series provides high 24-bit resolution and the Total Error Band after auto zero is as low as $\pm 0.25\%$ FSS. The Total Error Band of the HSC Series and SSC Series depends on the pressure range, with the HSC Series as low as $\pm 1\%$ FSS and the SSC Series as low as $\pm 2\%$ FSS.
- **Contaminant and corrosion resistant:** Ability to work with potential contaminants due to the wet/wet compatibility and a flow path with minimal dead space (26PC Series).
- **Product availability:** The sensor is available throughout the customers' product life cycle, so there is little concern for resubmission and approval to replace the sensors.
- **Reliable:** Minimizes downtime and improves throughput with enhanced quality and reliability (<100 ppm) (26PC Series).
- **Stable:** Enhanced accuracy in pressure monitoring to control the pumps and repeatable pressure, essential for the spectrum analysis. Stability is a measure of how little the output signal of the pressure sensor will change from measurement to measurement. The long-term stability of Honeywell's TruStability sensors is the best in the industry.



TruStability HSC Series,
SSC Series



Basic ABP Series



26PC Series



192 Series and 194 Series

Thermistor Sensing Elements

192 Series, 194 Series

Thermistor sensing elements are used to monitor the temperature of the chamber, the diffusion lamps, and oil-cooled motor to prevent them from overheating. There is also a need to measure the temperature as close to the sample as possible to control the sample temperature. Honeywell offers several types of configurations. The packaged sensors are available as discrete components for customer-built assemblies, or Honeywell can provide a full assembly solution that the customer may simply pigtail into the system.

Benefits to Customer

- **Application flexibility:** Bare leads (192 Series) or insulated leads (194 Series) are designed to provide application flexibility.
- **Cost-effective:** Resistance temperature curve interchangeability designed to offer standardization of circuit components and simplification of design and/or replacement enhances cost-effectiveness.
- **Small:** Small size often eases use in confined spaces.



AWM40000 Series

GAS CHROMATOGRAPHY

Gas chromatography is a laboratory technique used in analytical chemistry to separate and analyze compounds that can be vaporized without decomposition.

Airflow Sensors

AWM40000 Series

Medical gas chromatography requires precise and accurate monitoring and regulation of gas flow. Honeywell's airflow sensor's ceramic flow tube is designed to minimize outgassing with enhanced accuracy and reliability.

Benefits to Customer

- **Accurate:** Provides accurate delivery control of carrier gases at the required flow rate with enhanced sensitivity (the ability to detect ultra-low flow levels at 0.1 cm^3).
- **Eases implementation:** Provides optional manifold mounting to reduce customers' design and sensor implementation effort.
- **Minimizes risk of contamination:** Ceramic flow tube assembly with no outgassing minimizes risk of contamination.
- **Reliable:** Reduces downtime in many demanding operations with enhanced quality and reliability ($<100 \text{ ppm}$).
- **Stable:** Provides accurate control of flow rate over time for consistent, stable, repeatable test results with enhanced stability.



TruStability HSC Series, SSC Series

Pressure Sensors

Board Mount Pressure Sensors: TruStability™ HSC Series, SSC Series

Honeywell's TruStability board mount pressure sensor is used to sense and control gas stream pressure to maintain a constant and precise flow.

Benefits to Customer

- **Accurate:** TruStability sensors' exceptional accuracy is a result of leading-edge technology, precise manufacturing processes and temperature compensation and calibration. The Total Error Band of the HSC Series and SSC Series depends on the pressure range, with the HSC Series as low as $\pm 1 \text{ \%FSS}$ and the SSC Series as low as $\pm 2 \text{ \%FSS}$.
- **Stable:** Enhanced accuracy in pressure monitoring to control the pumps and repeatable pressure, essential for the spectrum analysis. Stability is a measure of how little the output signal of the pressure sensor changes from measurement to measurement. The long-term stability of Honeywell's TruStability sensors is the best in the industry.



Patient Monitoring Systems

Patient monitors are used in clinical environments (e.g., operating rooms, emergency rooms, intensive care, and increasingly, patient homes) to monitor and display the patient's vital signs, including ECG, SpO₂ (peripheral oxygen saturation), blood pressure, respiration, and temperature. Patient monitors can be standalone or multi-parameter. Honeywell sensors have been used in applications with blood pressure monitoring, glucose monitoring, respiratory monitoring, and temperature monitoring.

Blood pressure monitoring may be measured through either an inserted pressure transducer or non-invasively through a blood pressure cuff (NIBP).

Glucose monitoring measures the glucose level in the interstitial fluid. Continuous monitoring allows examination of how the blood glucose level reacts to insulin, exercise, food, and other factors. Potential sensor applications include the continuous glucose monitors used in critical care units, operating rooms, and patient recovery, where pumps are used to draw blood and/or return the blood to the body. Sensors could also be used in selected handheld devices if pressure needs to be regulated when drawing blood.

Respiratory monitoring displays critical indices including capnography, which monitors the concentration or partial pressure of CO₂ in respiratory gases, and spirometers, which measure direct in- and out-flow. Temperature monitoring consists of monitoring patient temperature.

Sensor Solutions for Patient Monitoring

Respiratory Monitoring: Airflow Sensors

Blood Glucose Monitoring: Pressure Sensors

Blood Pressure Monitoring: Pressure Sensors

Temperature Monitoring: Thermistor Sensing Elements

RESPIRATORY MONITORING: Airflow Sensors

Honeywell Zephyr™ HAF Series

Zephyr Airflow Sensors measure the flow of air, oxygen, and nitrous oxide. They may be used so that the desired mixture, as set by the doctor, is delivered to the patient.

Benefits to Customer

- **High 2.5% accuracy:** Allows for very precise airflow measurement, often ideal for demanding applications with high accuracy requirements.
- **Customizable:** Allows the sensor to be designed to meet specific end-user needs.
- **High sensitivity at very low flows:** Allows the customer's application to detect presence or absence of airflow.
- **High stability:** Reduces errors due to thermal effects and null shift to provide accurate readings over time, often eliminating need for system calibration after printed circuit board (PCB) mount and periodically over time.
- **Low pressure drop:** Low pressure drop typically improves patient comfort in medical applications, and reduces noise and system wear in components such as motors and pumps.
- **Saves customers time and money:** Linear output provides a more intuitive sensor signal than the raw output of basic airflow sensors, often eliminating the need for customers having to linearize the output which can help to reduce production and design costs and implementation time.



HAF Series - Low Flow



HAF Series - High Flow



TruStability HSC Series, SSC Series



24PC Series, 26PC Series



192 Series and 194 Series

BLOOD GLUCOSE MONITORING: Pressure Sensors

Board Mount Pressure Sensors: TruStability™ HSC Series, SSC Series

Honeywell's TruStability board mount pressure sensors are used to control the pumps that draw blood and return it to the patient in continuous glucose monitors used in critical care units. These pressure sensors meet the size requirements for handheld glucose meters equipped glucose monitoring pressure measurement.

Benefits to Customer

- **Improves patient safety with best-in-class low drift:** Allows accurate control of the pump pressure.
- **Accurate:** Allows blood pressure measurement with enhanced stability and minimal drift over time. Honeywell's TruStability sensors' exceptional accuracy is a result of leading-edge technology, precise manufacturing processes, and temperature compensation and calibration. The Total Error Band of the HSC Series and SSC Series depends on the pressure range, with the HSC Series as low as ± 1 %FSS and the SSC Series as low as ± 2 %FSS, better than most competitive products.
- **Portability:** Small sensor size improves handheld glucose monitor portability.
- **Stable:** Stability is a measure of how little the output signal of the pressure sensor changes from measurement to measurement. The long-term stability of Honeywell's TruStability sensors is the best in the industry.

BLOOD PRESSURE MONITORING: Pressure Sensors

Board Mount Pressure Sensors: TruStability HSC Series, SSC Series; 24PC Series; 26PC Series

Honeywell's board mount pressure sensors may be used in blood pressure monitors to measure blood pressure.

Benefits to Customer

- **Accurate:** Accurate pressure monitoring in blood pressure monitors allows blood pressure measurement with enhanced stability and minimal drift over time. Honeywell's TruStability sensors' exceptional accuracy is a result of leading-edge technology, precise manufacturing processes, and temperature compensation and calibration. The Total Error Band of the HSC Series and SSC Series depends on the pressure range, with the HSC Series as low as ± 1 %FSS and the SSC Series as low as ± 2 %FSS, better than most competitive products.
- **Portability:** Small sensor size improves blood pressure monitor portability.
- **Stable:** Stability is a measure of how little the output signal of the pressure sensor changes from measurement to measurement. The long-term stability of Honeywell's TruStability sensors is the best in the industry.

TEMPERATURE MONITORING: Thermistor Sensing Elements

192 Series, 194 Series

Honeywell's 192 Series and 194 Series thermistor sensing elements are used to monitor patient temperature. Honeywell offers several types of configurations. The packaged sensors are available as discrete components for customer-built assemblies, or Honeywell can provide a full assembly solution that the customer may simply pigtail into the system.

Benefits to Customer

- **Application flexibility:** Bare leads (192 Series) or insulated leads (194 Series) are designed to provide application flexibility.
- **Cost-effective:** Resistance temperature curve interchangeability designed to offer standardization of circuit components and simplification of design/replacement enhances cost-effectiveness.
- **Small:** Small size often eases use in confined spaces.



Hospital Hardware

Honeywell's sensors and switches have been used in a variety of hospital hardware to help minimize downtime, provide stable and repeatable performance, and meet demanding requirements in harsh environments.

Solutions for Hospital Hardware

Medication Dispensing Cabinets: Hall-effect Position Sensor ICs

Infant and Laboratory Incubators:

- Humidity Sensors
- Thermistor Sensing Elements

Hospital Beds:

- MICRO SWITCH Basic Switches
- Pressure Sensors

Sterilizers, Autoclaves, and Blood Refrigerators: Thermistor Sensing Elements

MEDICATION DISPENSING CABINETS: Hall-effect Position Sensor ICs SS440R Series

Hall-Effect position sensor ICs are designed for a variety of potential applications, including use with remote locking and unlocking of medication dispensing cabinets. Their small size often allows for design into many compact, automated, lower-cost assemblies. A thermally-balanced integrated circuit allows accuracy over a full temperature range.

Benefits to Customer

- **Energy-efficient:** Low power consumption enhances energy efficiency.
- **Enhances security:** Provides a level of security; minimizes medication dispensing errors by utilizing electronic sensing solutions to enable remote locking and unlocking of medication drawers.
- **Fast response:** Provides fast response time.
- **Reliable:** Improves durability and reduced repair and maintenance cost with a non-contact solution.
- **Small:** Small sensor size eases fit in drawers and enables smooth and efficient operation.

INFANT AND LABORATORY INCUBATORS: Humidity Sensors

Honeywell HumidIcon™ HIH6000 Series, HIH-4030/4031 Series, HIH-5030/5031 Series, HIH-4020/4021 Series, HIH-4000 Series

Honeywell's humidity sensors monitor the medical incubator system to maintain a desired optimum level of humidification in the chamber with accurate dew-point and absolute humidity and moisture measurement.

Benefits to Customer

- **Industry-leading long term stability (1.2 RH% over 5 years):** Minimizes system performance issues, helps support system uptime, and eliminates the need to recalibrate the sensor in the application (HumidIcon).
- **Industry-leading Total Error Band (TEB) ($\pm 5\%RH$):** Provides the sensor's true accuracy reducing manufacturing time, supports system warranty requirements, helps optimize system uptime, and provides excellent sensor interchangeability (HumidIcon).



SS440R Series

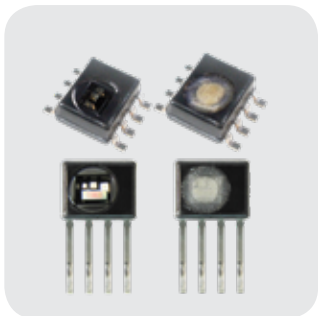

HumidIcon HIH6000 Series

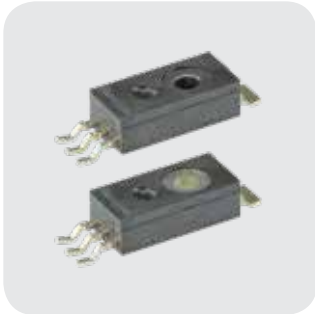

HIH-4030/4031 Series

- **Lowest total cost solution:** Offers customers the lowest total cost solution due to the sensor's industry-leading Total Error Band and being a combined humidity/temperature sensor (HumidIcon).
- **Cost-effective:** Surface mount device (SMD) packaging on tape and reel allows for use in automated, high-volume, lower-cost, pick-and-place manufacturing.
- **Durable:** Multi-layer construction and a hydrophobic filter provides enhanced resistance to condensation and contaminants.
- **Flexible:** Small, space-saving housing profile allows for application flexibility. The low current draw allows for use in low-current-drain, battery-operated systems.
- **Reliable:** Supports demanding system performance requirements with enhanced accuracy and response time.



HIH-4020/4021 Series

INFANT AND LABORATORY INCUBATORS: Thermistor Sensing Elements

192 Series, 194 Series

Honeywell's discrete thermistor sensing elements are designed to monitor temperature. The sensors are coupled to a microcontroller designed to measure air stream temperature and interact with the controller that regulates the air stream temperature. The packaged sensors are available as discrete components for customer-built assemblies, or Honeywell can provide a full assembly solution that the customer may simply pigtail into the system.

Benefits to Customer

- **Application flexibility:** Bare leads (192 Series) or insulated leads (194 Series) are designed to provide application flexibility.
- **Cost-effective:** Resistance temperature curve interchangeability designed to offer standardization of circuit components and simplification of design/replacement enhances cost-effectiveness.
- **Small:** Small size often eases use in confined spaces.



HIH-4000 Series

HOSPITAL BEDS: MICRO SWITCH Basic Switches

SM Series, SX Series, Z Series

Honeywell's precise position switches are used to determine minimum and maximum position of electrically adjustable hospital beds.

Benefits to Customer

- **MICRO SWITCH technology:** Accurate, repeatable, and durable with extended life.
- **Customizable:** Offers a variety of straight, roller, simulated roller, and special actuators from which to choose.
- **Reliable:** Provides repeatable and consistent performance within a range of conditions.
- **Industry-leading current capability:** A wide range of current ratings, from 0.1 A to 10 A.



192 Series, 194 Series



SX Series, SM Series,
Z Series



TruStability HSC Series,
SSC Series



Basic NPB Series



24PC Series, 26PC Series



192 Series and 194 Series

HOSPITAL BEDS: Pressure Sensors

Board Mount Pressure Sensors: TruStability™ HSC Series, SSC Series; Basic NBP Series; 24PC Series; 26 PC Series

Honeywell's board mount pressure sensors are used to measure air pressure and monitor the inflation and deflation of the mattress air columns to minimize the chance that bedridden patients will develop bedsores.

Benefits to Customer

- **Accurate:** Accurate pressure monitoring in hospital beds allows enhanced stability and minimal drift over time. Honeywell's TruStability sensors' exceptional accuracy is a result of leading-edge technology, precise manufacturing processes, and temperature compensation and calibration. The Total Error Band of the HSC Series and SSC Series depends on the pressure range, with the HSC Series as low as ± 1 %FSS and the SSC Series as low as ± 2 %FSS, better than most competitive products.
- **Reliable:** In demanding operations minimizes downtime and improves throughput with enhanced quality and reliability (<100 ppm).
- **Stable:** The long-term stability of Honeywell's TruStability sensors is the best in the industry.
- **Cost-effective:** Basic NBP Series provide a cost-effective pressure sensing solution with a variety of options that allow customers to meet their specific application needs (NBP Series).

STERILIZERS, AUTOCLAVES, AND BLOOD REFRIGERATORS: Thermistor Sensing Elements

192 Series, 194 Series

Honeywell's thermistor sensing elements are designed to monitor temperature. The sensors are coupled to a microcontroller designed to measure air stream temperature and interact with the controller that regulates the air stream temperature. The packaged sensors are available as discrete components for customer-built assemblies, or Honeywell can provide a full assembly solution that the customer may simply pigtail into the system.

Benefits to Customer

- **Application flexibility:** Bare leads (192 Series) or insulated leads (194 Series) are designed to provide application flexibility.
- **Cost-effective:** Resistance temperature curve interchangeability designed to offer standardization of circuit components and simplification of design/replacement enhances cost-effectiveness.
- **Small:** Small size often eases use in confined spaces.



Surgical Instruments

Honeywell sensors have been used to help control the operation of various surgical instruments including orthopedic bone drills to detect the force of the drill bits and improve patient safety, regulating air and gas pressure in endoscopes, controlling the pressure level for patient wound suction therapy, and sensing pressure in a fluid management system.

Sensor Solutions for Surgical Fluid Management Systems

- Force Sensors
- Pressure Sensors



1865 Series

Force Sensors in Surgical Fluid Management 1865 Series, FSS Series, FSS-SMT Series

Honeywell's force sensors can help regulate the pressure at the pump head of a fluid management system, and as a back-up safety device to the direct pressure measurement at the joint.

Benefits to Customer

- **Portable:** Small sensor size improves portability.
- **Energy efficient:** Small sensor size allows lower power consumption.
- **Reliable:** Enhanced quality (<100 ppm) provides enhanced reliability in many demanding operations.
- **Rugged design:** Offers a rugged design that resists scratching and denting.
- **Stable:** Ability to detect pressure accurately over time with enhanced stability and low drift (1865 Series).



FSS Series, FSS-SMT Series

Pressure Sensors in Surgical Fluid Management Systems and Insufflators

Board Mount Pressure Sensors: TruStability™ HSC Series, SSC Series

Honeywell's TruStability board mount pressure sensors are used to sense pressure directly at the joint site during arthroscopic surgery, and monitor pressure for insufflators during endoscopic procedures.

Benefits to Customer

- **Accuracy:** Enhanced accuracy and ability to detect low pressure improves pressure measurement accuracy. TruStability sensors' exceptional accuracy is a result of leading-edge technology, precise manufacturing processes, and temperature compensation and calibration. The Total Error Band of the HSC Series and SSC Series depends on the pressure range, with the HSC Series as low as $\pm 1\%$ FSS and the SSC Series as low as $\pm 2\%$ FSS, better than most competitive products.
- **Improves patient safety:** Allows quick reaction with a fast response time.
- **Easy to design in:** Customization of pressure ranges, connections, calibration, and temperature compensation minimizes customer's design-in effort.
- **Stable:** Stability is a measure of how little the output signal of the pressure sensor will change from measurement to measurement. The long-term stability of Honeywell's TruStability sensors is the best in the industry.



TruStability HSC Series, SSC Series



Basic NBP Series

Pressure Sensors in Wound Therapy

Board Mount Pressure Sensors: Basic NBP Series

Wounds may be caused by burns, ulcers, surgery, accidents, or pressure sores (e.g., bedsores). Physicians may use negative-pressure wound therapy to promote healing by creating controlled negative pressure over the wound. Honeywell's Basic NBP Series board mount pressure sensors may be used to monitor the pressure applied to the wound via the suction system.

Benefits to Customer

- **Optimizes therapy:** Allows the desired suction so the patient is not harmed.
- **Small:** Package size is very small when compared to most competitive devices, occupying less space on the PCB and typically allowing for easy placement on crowded PCBs or in small devices.
- **Durable:** Wide operating temperature range from -40°C to 125°C [-40°F to 257°F] and a variety of media compatibility options allow for use in tough environments.



Dental Equipment

Honeywell's sensors may potentially be used in many dental equipment applications including dental imaging systems, dental chairs, and pressure-operated dental instruments including drills, water sprays, and air blasters.

Sensor Solutions for Dental Equipment

Dental Chairs:

- Hall-effect Position Sensor ICs
- MICRO SWITCH Watertight Miniature Switches

Dental Imaging Systems:

- Hall-Effect Position Sensor ICs

Pressure-Operated Dental Instruments:

- Board Mount Pressure Sensors



V15W Series

DENTAL CHAIRS: MICRO SWITCH Watertight Switches

V15W Series, ZW Series, ZD Series

These miniature-sized basic switches can be used in automatic dental chair foot pedals to control chair position, limiting the dental staff from touching items and risking cross contamination.

Benefits to Customer:

- **MICRO SWITCH technology:** Accurate, repeatable, and durable with extended life.
- **Customizable:** Offers a variety of straight, roller, simulated roller, and special actuators from which to choose.
- **Reliable:** Provides repeatable and consistent performance within a range of conditions.
- **Industry-leading current capability:** A wide range of current ratings from 0.1 A to 10 A.



ZW Series, ZD Series

DENTAL IMAGING SYSTEMS: Hall-Effect Position Sensor ICs

Micropower SL353 Series, SS549AT

Hall-effect position sensor ICs are used to provide accurate motion control and positioning of the dental imaging system.

Benefits to Customer

- **Energy efficient:** Hall-effect sensors consume little energy and help improve motor efficiency. The Micropower SL353 Series' supply voltage (as low as 2.2 Vdc), combined with very low average current, reduces power consumption and provides extended battery life.
- **Push-pull output does not require external pull-up resistor:** Simplifies interface with common electrical circuits and potentially reduces PC board space and costs to the customer (Micropower SL353 Series).
- **Non-chopper stabilized design:** Does not utilize chopper stabilization, eliminating noise generated by products using this technique (Micropower SL353 Series).
- **Accurate motion control:** Detects home position and different segments of the sensor head rotation.
- **Fast response:** Provides a fast response time.
- **Reliable:** Improved durability and reduced repair and maintenance cost with a non-contact solution.

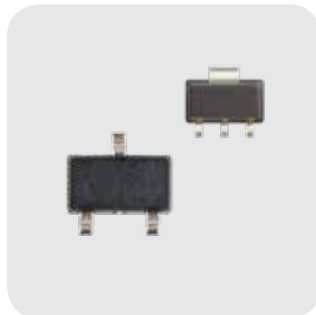

Micropower SL353 Series, SS549AT



26PC Flow-Through Series

PRESSURE-OPERATED DENTAL INSTRUMENTS: Pressure Sensors

Board Mount Pressure Sensors: 26PC Flow-Through Series

Honeywell's 26PC Series board mount pressure sensors are used to keep the water flow constant and at an adjusted level to provide smooth operation of dental instruments (e.g., drills, water sprays, air blasters).

Benefits to Customer

- **Reliable:** Minimizes downtime in demanding operations, and improves throughput with enhanced quality and reliability (<100 ppm).
- **Stable:** Pressure monitoring to control water flow level with enhanced accuracy.
- **Water-resistant and contaminant-resistant:** Ability to work with water flow and contaminants with the wet/wet compatibility and a flow path with minimal dead space.

Warranty/Remedy

Honeywell warrants goods of its manufacture as being free of defective materials and faulty workmanship during the applicable warranty period. Honeywell's standard product warranty applies unless agreed to otherwise by Honeywell in writing; please refer to your order acknowledgment or consult your local sales office for specific warranty details. If warranted goods are returned to Honeywell during the period of coverage, Honeywell will repair or replace, at its option, without charge those items that Honeywell, in its sole discretion, finds defective. **The foregoing is buyer's sole remedy and is in lieu of all other warranties, expressed or implied, including those of merchantability and fitness for a particular purpose. In no event shall Honeywell be liable for consequential, special, or indirect damages.**

While Honeywell may provide application assistance personally, through our literature and the Honeywell web site, it is buyer's sole responsibility to determine the suitability of the product in the application.

Specifications may change without notice. The information we supply is believed to be accurate and reliable as of this writing. However, Honeywell assumes no responsibility for its use.

For more information

Honeywell Sensing and Internet of Things services its customers through a worldwide network of sales offices and distributors. For application assistance, current specifications, pricing or the nearest Authorized Distributor, visit sensing.honeywell.com or call:

Asia Pacific	+65 6355-2828
Europe	+44 (0) 1698 481481
USA/Canada	+1-800-537-6945

Honeywell Sensing and Internet of Things

9680 Old Bailes Road
Fort Mill, SC 29707
www.honeywell.com

000694-4-EN | 4 | 11/18
© 2018 Honeywell International Inc. All rights reserved.

The Honeywell logo, consisting of the word "Honeywell" in a bold, red, sans-serif font.