

EMPOWERING ENGINEERS TO BUILD THE FUTURE

EXPERT ADVICE

ISSUE 1

INDUSTRY4.0



**GROOV EPIC -
AUTOMATION & IIOT
MADE SIMPLE**

+

BOOSTING FACTORY EFFICIENCY

EMBRACE EDGE COMPUTING
IN SMART FACTORIES

TAKE CONTROL OF
YOUR SHOP FLOOR

MONITOR MACHINE
VIBRATION LIKE A PRO

MASTER DC MOTOR
CONTROL POWER

TAME HARMONICS FROM VFDS

PREFACE

Welcome to the inaugural edition of our Expert Advice! We are thrilled to present a diverse and insightful collection of articles that delve into the realm of engineering design and its applications in optimizing factory production systems.

In this first edition, we bring together a range of topics that address the pressing challenges faced by engineers in the industry. Our esteemed authors have shared their expertise and knowledge to offer practical solutions to enhance energy efficiency, harness edge computing, establish secure access controls, facilitate cloud integration, monitor machine vibrations, optimize motor control, and mitigate harmonics generated by VFDs.

These articles provide valuable insights into the latest advancements and best practices in engineering design, ensuring that developers stay at the forefront of innovation in the field. From strategies to optimize energy efficiency in factory production systems to the implementation of edge computing for smart factory applications, each article explores a specific facet of engineering design.

Whether you are an engineer, researcher, or industry professional, this journal serves as a comprehensive resource to expand your understanding and skill set. We believe that the knowledge shared within these pages will empower you to overcome challenges, drive technological advancements, and ultimately contribute to the success of your projects.

We invite you to immerse yourself in this exciting journey of engineering design as we explore the intricacies of optimizing energy efficiency, leveraging cutting-edge technologies, and creating sustainable solutions in the realm of Industry 4.0.



Cliff Ortmeyer, Editor
Email: editor-TJ@element14.com

CONTENTS



03

OPTIMIZE ENERGY EFFICIENCY

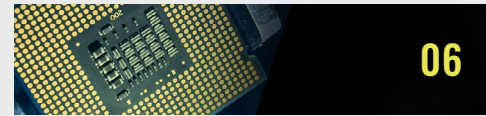

06

EDGE COMPUTING FOR SMART FACTORY



09

CONTROL ACCESS TO SHOPFLOOR SYSTEMS



11

GROOVEPIC-MQTT-AWS



16

LOGIC CONTROLLERS IN VIBRATION MONITORING

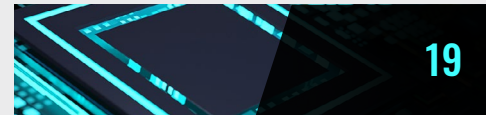

19

DRIVE DC MOTOR WITH ICS

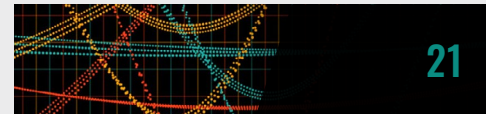

21

HARMONICS GENERATED BY VFDS

Editor-in-chief: Cliff Ortmeyer,
Managing Editor: Ankur Tomar

©Premier Farnell. All rights reserved. No portion of this publication, whether in whole or in part, can be reproduced without the express written consent of Premier Farnell. All other registered and/or unregistered trademarks displayed in this publication constitute the intellectual property of their respective holders. Errors and omissions in the printing of this magazine shall not be the responsibility of Premier Farnell. Premier Farnell reserves the right to make such corrections as may be necessary to the prices contained herein.



Scan QR code to register
and to access all issues of
Expert Advice

HOW TO OPTIMIZE **ENERGY EFFICIENCY** IN FACTORY PRODUCTION SYSTEMS

Electric motors are the main power units behind almost all automation devices in production plants. Over 40 percent of generated electricity is consumed by industry and two-thirds of energy is used by electric motors.

Losses are an inevitable part of running a motor and they directly affect efficiency. Losses are minimised by using higher cutting edge motor designs, proper motor control selection, and considering the torque of the motor in high precision automated production systems.



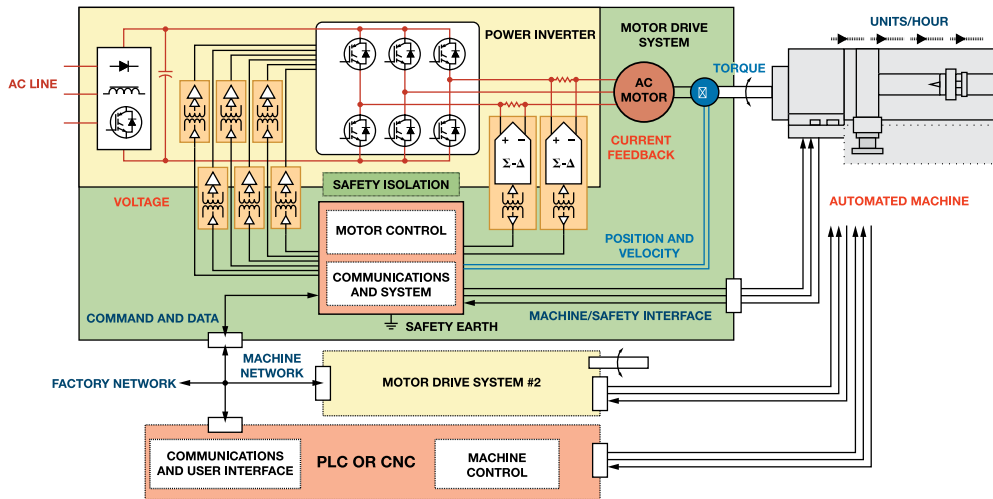

Figure 1: Block diagram of automated machine control system

Figure 1 describes the main elements in an automated machine or process found in a modern factory. The efficiency of the motors and the whole production process is determined by multiple control layers.

The first control layer adjusts the power inverter switching sequence to manage the motor voltage and current and enhance torque production efficiency. Next is the position and speed controller that operates the machine efficiently.

In process equipment, this could be a sequence of speed or position orders to perform an assembly function, whereas, in automation equipment, this could be a sequence of speed or position commands to execute an assembly function.

In the latter scenario, the response time of the speed control will be more critical to the machine controller than torque production efficiency. As multiple motors are now synchronised across high-speed data networks that are also connected to the factory network, the communications and systems layer is becoming increasingly important.

The torque produced per amp supplied at any given speed and terminal voltage influences motor efficiency. Torque is generated by electric motors by forces that tend to align their internal magnetic fields.

When the stator currents are synchronised with the rotor motion to maintain continuous field misalignment, AC motors produce constant torque. The frequency of the motor currents is closely connected to the ac motor speed, therefore speed regulation necessitates the use of a variable frequency voltage source, such as VSDs or VFDs.

When the rotor-stator field misalignment is at its maximum, the efficiency is maximum. Motor efficiency also depends upon motor construction and particularly the rotor field structure. Permanent magnet synchronous motors (PMSM) are more efficient, since no current is required to magnetise the rotor field.

Because of their prominent magnetic core construction, ultrahigh efficiency interior permanent magnet (IPM) motors generate additional torque.

Using Soft Starters in AC Induction Motors:

When starting, the AC Induction motor develops more torque than is required at full speed. This stress is transferred to the mechanical transmission system, causing excessive wear and premature failure of chains, belts, gears, mechanical seals, and other components.

Rapid acceleration also has a significant influence on electricity supply charges, with high inrush currents drawing +600% of the normal run current. The use of Star Delta only provides a partial solution to the problem.

If the motor slows down during the transition time, the high peaks will be repeated and may potentially exceed direct on line current.

Soft starters provide a reliable and economical solution to these issues by delivering a controlled release of power to the motor, resulting in smooth, step-less acceleration and deceleration, as illustrated in Figure 2.

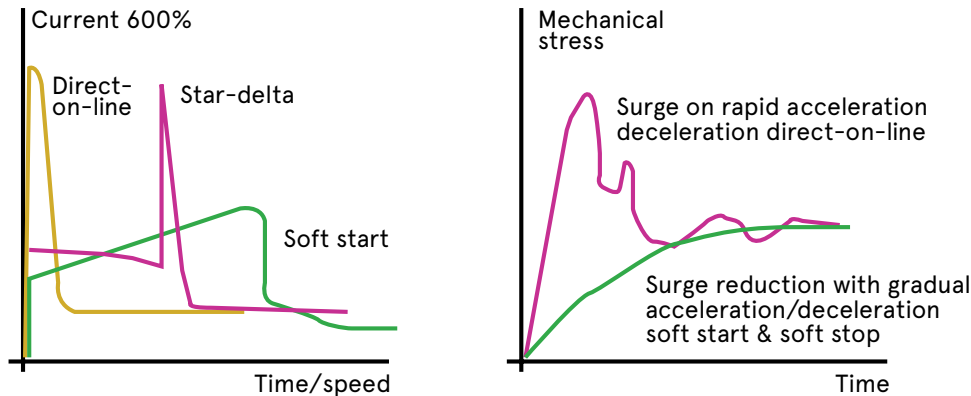

Figure 1: Performance curve as compared to direct-on line, Star-delta and Soft Start

As damage to windings and bearings is reduced, motor life will be extended. Soft Start & Soft Stop is incorporated into three-phase systems, allowing for regulated starting and stopping with a selection of ramp times and current limit settings.

By adopting predictive and condition monitoring::

Condition Monitoring (CM) is the monitoring of several parameters such as equipment vibration and temperature to identify potential concerns such as misalignments or bearing failures.

When a vibration analysis reveals a change in the harmonic frequency of rotating equipment components, condition monitoring tools can map equipment degradation.

Frequency analysis can be performed using both vibrometer and microphone data. Continuous Predictive and Condition Monitoring techniques might be used on a range of equipment, including compressors, pumps, spindles, and motors, and they can also be used to detect partial discharge on machines or vacuum leaks. This analysis helps factories to maximise efficiency and equipment availability whilst lowering costs.

Improving efficient motion control with precision isolation and effective communications:

The combination of precision in motion control and communication timing enables shorter machine production cycles and reduces the amount of energy consumed to manufacture each part. PMSM service motors and drives designed for fast response and high precision in speed and position control are used by drive manufacturers to assist automation applications.

The use of high-speed magnetic isolation technology allows for the safe isolation of analog and digital signal voltages without sacrificing speed or precision. Precision **analog-to-digital converters** integrated into the encoder position offer position feedback with up to a 24-bit resolution, enabling high dynamic velocity control at rates as low as 1 RPM.

This level of performance is appropriate for automation applications such as multi-axis milling of precision machine parts, assembly of fine geometry integrated circuits, and injection molding of cell phone parts.

Furthermore, to ensure control precision, the motors' motion timing should be perfectly synchronised, because a timing error directly translates into a trajectory error in multi-axis position control.

Industrial Ethernet protocols, such as **PROFINET** and **EtherCat**, use modified Ethernet network interfaces to support real-time data synchronisation with clock jitter as low as 1µs. These network interfaces support both synchronised motion control and factory network connectivity for production system management.

Explore the widest range or Motor controls & Drive

Click here 

HOW TO IMPLEMENT DIFFERENT TYPES OF **EDGE COMPUTING** FOR SMART FACTORY APPLICATION

More extensive uses of edge computing will use servers that are much closer to the industrial plant, some in shared facilities with others owned or rented directly by the plant operator to host vital, high-performance applications.

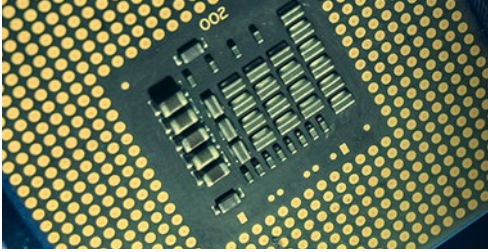

Industrial units utilise edge-computing hardware which will filter the data produced by local machines and update the most important aspects to a remote data Centre or cloud infrastructure. In Smart edge technologies IIoT devices, sensors, actuators, and controllers are used to track the health of equipment and the moving parts within it. With edge computing, the machine does not need to communicate with the central cloud before making a decision that will preserve the equipment and reduce downtime in real-time.

Distributed computing infrastructure and Data processing are two major components of edge computing. Depending upon the complexity of the analytics needed, the computing infrastructure might range from a simple MCU to a high end GPU. Edge computing comprises of compute, storage, data management, data analysis and networking amongst others. The information is transferred to the cloud for further analysis or integration into a bigger system depending upon the complexity.

Many of the sensors used on the shopfloor are wireless, communicating via Bluetooth, Wifi, Zigbee, or Thread protocols. These sensors may not use typical fieldbus-over-TCP/IP protocols, instead relying on IoT-specific standards like CoAP and MQTT.

Intelligent industrial gateways often have a CPU capable of running a sophisticated operating system like Linux or Windows 10, as well as software tools like Node-RED and general-purpose programming languages like C, C++, and Python.

As cited in the whitepaper titled "Edge computing in the industrial environment" in the section "The forms of edge computing", the edge devices are formed into thick, thin and micro edge sublayers. The thick edge, or the thick-compute layer, includes the on-premises data centres and shared facilities operated by internet or cellular service providers and others who will provide on-demand access for computing and storage resources. It covers the traditional way which has been used to run SCADA and similar applications. The thin edge and the micro edge represent the layer that is closest to the shopfloor machinery and the part of the industrial computing ecosystem that is the most mature. The thin edge includes devices such as PLCs and specialised embedded computers that are built into machine tools and other production equipment.

The micro edge represents the sensors that acquire data from process and manufacturing equipment that, traditionally, have been directly attached to PLCs. Industrial Edge and Enterprise Edge are the two technologies to be considered.

In Industrial Edge, large numbers of sensors are connected with different protocols, different data sources, and incompatible data formats, bridging industrial equipment and factory systems to meet the digital world. When coming to Enterprise Edge, it computes resources and manages Industrial Edge and deploys enterprise-level infrastructure on the factory floor.

Use case: Smart Factory Solution

As shown in below figure a Smart Factory Solution has the capability to connect multiple sensors to monitor the status, automate, collect data, analyse it and derive useful insights to improve manufacturing operations. Industrial edge computing can be set up in such a way that an enterprise reaps the benefits of both edge computing and the scalable resources of cloud computing.

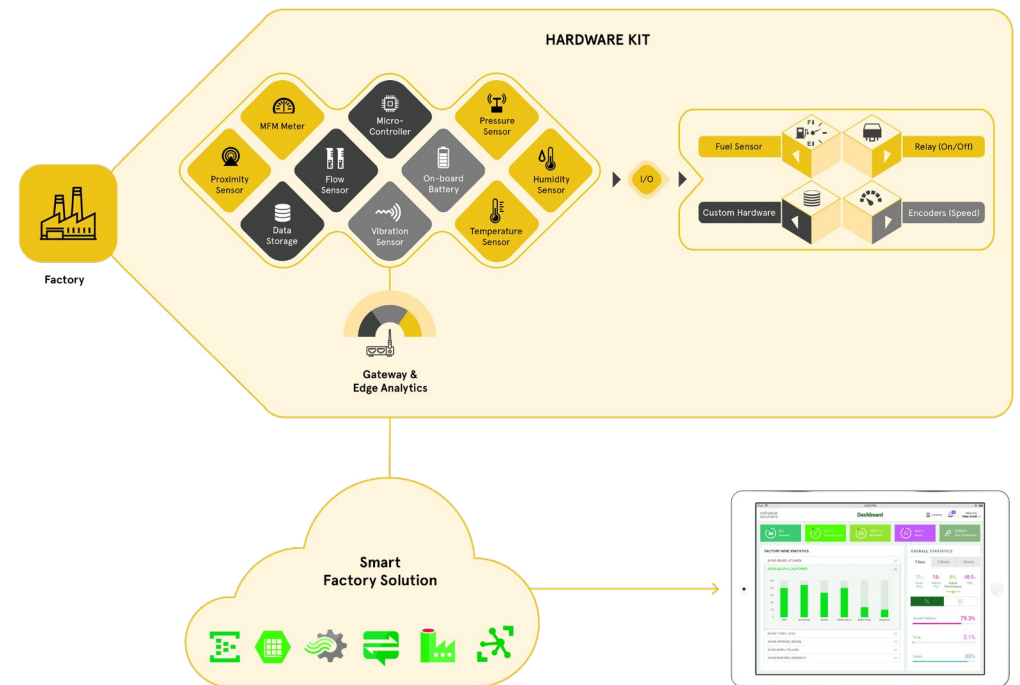

Figure : Smart Factory Solution

As depicted in preceding figure, it involves Site assessment whereby a technical team will identify machines which are smart, semi-smart and dumb. Smart machines can be connected directly to the cloud. Semi-smart machines can provide a few data points directly to cloud and require external sensors/actuators in order to send any further data points. Dumb devices cannot provide any data and require external sensors/actuators to connect and send particular data to the cloud.

Edge analytics pushes the communication capabilities, processing power, and the intelligence of the edge gateways directly into devices such as programmable automation controllers (PACs).

It involves demand forecasting and capacity planning, Predictive maintenance with advanced algorithms, Real-time demand visibility, Suggest supply chain bottlenecks, Detect anomalies at the edge and symptoms for equipment failures.

Explore our widest range of Intelligent IoT Gateways and Single Board Computers for smart factory applications

Industrial Gateways ↗

Single Board Computers ↗

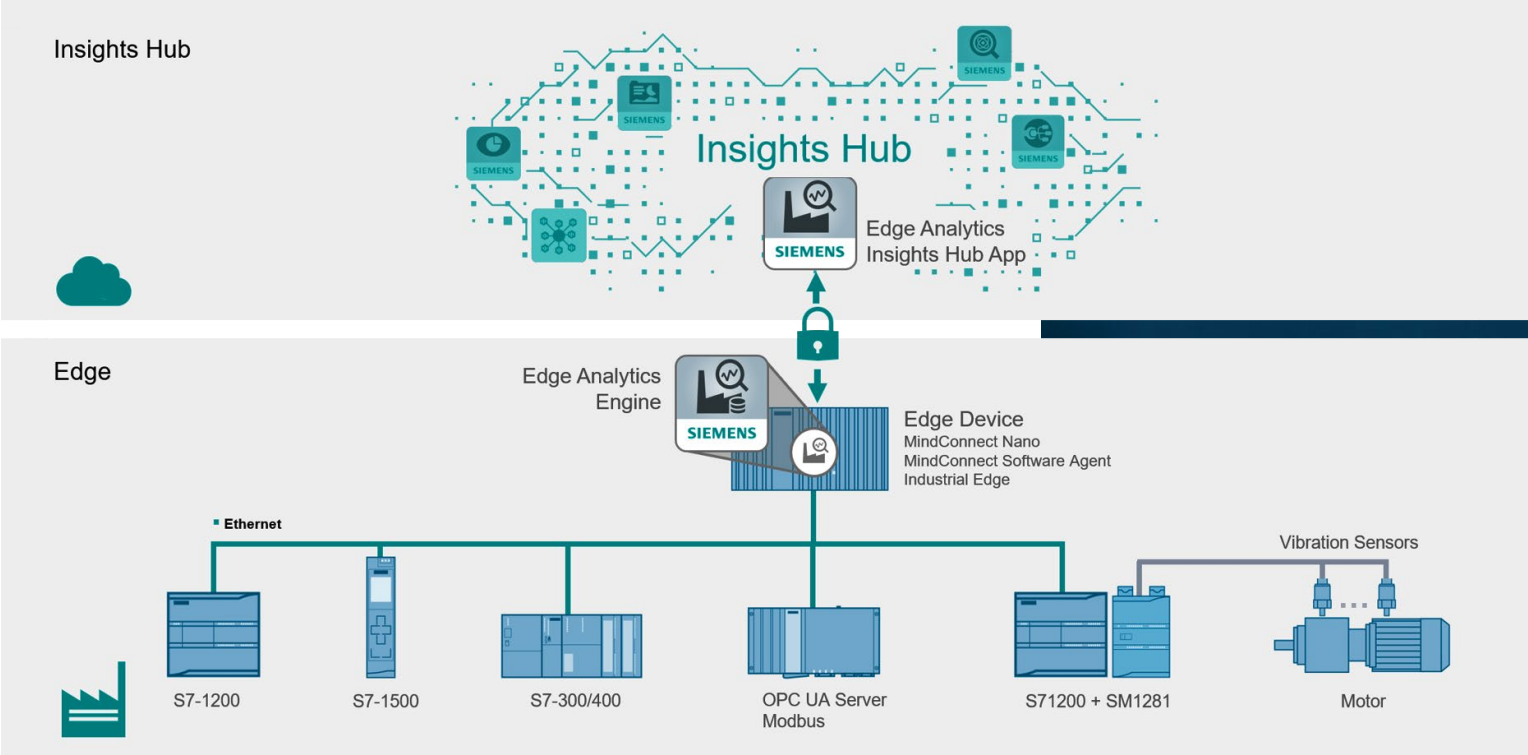

Figure : Connecting intelligence to assets



HOW TO ESTABLISH CONTROL ACCESS TO SHOP FLOOR SYSTEMS VIA GATEWAYS

A Smart Factory integrates data from system-wide physical, operational, and human assets to drive maintenance, manufacturing, digitisation of operations, inventory tracking, and more with a real-time view of production operations and all the ancillary units at the plant.

Moving more of the shop floor to PACs (Programmable automation controller) and intelligent gateways may considerably simplify the installation of new hardware. The enhanced benefits of using AI/ML include a new predictive maintenance model for shop floor assets and monitoring real-time health of assets/production lines. The shop floor is provided with IoT/Sensors to analyse, monitor, and record machine and operator data.

On the shop floor, access control is comprised of a multiple of professionally installed and electronically controlled components (PLCs, PACs, door readers, motion detectors, and so on). Temperature, humidity, lighting levels, and noise volume can be collected alongside machine data to correlate the impacts on process performance. Operator biometrics and performance may be recorded to improve operator safety and offer a work environment that is tailored to the operator's needs.

Shop floor communication ideas:

Some PLCs and sensors present on the shop floor use standard protocols like TCP/IP, Modbus, CAN or others, there are streaming protocols such as OPC, MQTT, REST and more. Automation controllers on the shop floor offer machine-to-machine (M2M) communication which enables effective process execution at the machine level.

The devices interact directly with each other by using a wired or wireless communication channel and dedicated protocols. Machine to Enterprise (M2E) enables effective process execution at the management or enterprise level. In this scenario, the vendor's application software accesses shop floor data stored on the database without being included in the complex shop floor processes.

The Edge Network Gateway:

The Gateway must be able to communicate on both the OT and IT sides. Collecting data would necessitate understanding the languages of various PLCs, not just from different manufacturers but also from different legacy products. Gateways can function as an edge device, gathering data, buffering it, and even grooming it before sending it to higher-level analytics software.

The edge gateway allows remote industrial devices to wirelessly communicate with next-generation intelligent infrastructure. Many of the sensors used on the shop floor are wireless, connecting via protocols such as Bluetooth, Wifi, Zigbee, or Thread.

This allows them to be deployed in places where cables are difficult to reach. As illustrated in Figure 1, an edge gateway consists of serial ports (RS 232, RS 485, and Ethernet).

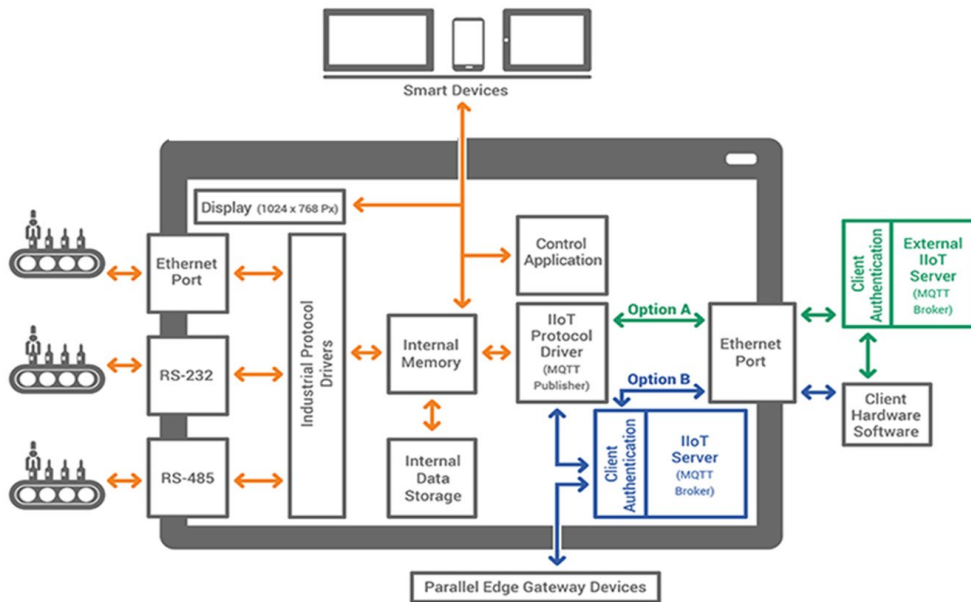

Figure 1: Edge Network Gateway

The dual-Ethernet ports allow dedication of one port for real-time industrial control network demands whilst the other is reserved for external network connections and IloT functionality.

Distinctly separate Ethernet ports offer added security, since a direct network path does not exist to the machinery itself.

Gateways can communicate with a variety of existing devices and support emerging IloT protocols such as CoAP, MQTT, and OPC UA. MQTT is one of several internet-enabled features that improves communication and data collection. Custom server/client applications enable smart device integration (Android/Apple gadgets) for machine monitoring and control, moving the touchscreen out of the panel and into the operator's hands.

Use case: Smart Asset Monitoring

As illustrated in the figure below, IoT-enabled smart asset monitoring with IloT Gateway and IoT Connect Platform (enterprise-ready IoT Platform) combines all processes, assets, workflows, and analytics into a single solution to have a centrally consolidated tracking, monitoring, and analytics system for asset-intensive sectors.

The system coupled with seamless, secure connectivity delivers a powerful set of features to gather, analyse and provide actionable, real-time data visualisation.

IloT Gateway connects devices on the shop floor system and permits inter-device communication and cyber-physical systems development. It also has the capability to connect multiple sensors, can collect data at high speeds and build an information model at the data source that contains the batch, serial numbers and corresponding production data, at each stage.

This information model can be pushed to data storage or enterprise platform applications, either on premise or in the cloud. With accurate production data, enterprise platform applications may now allow both process engineers and data scientists to do RCA (Root Cause Analyses) and prevent similar quality concerns in the future.

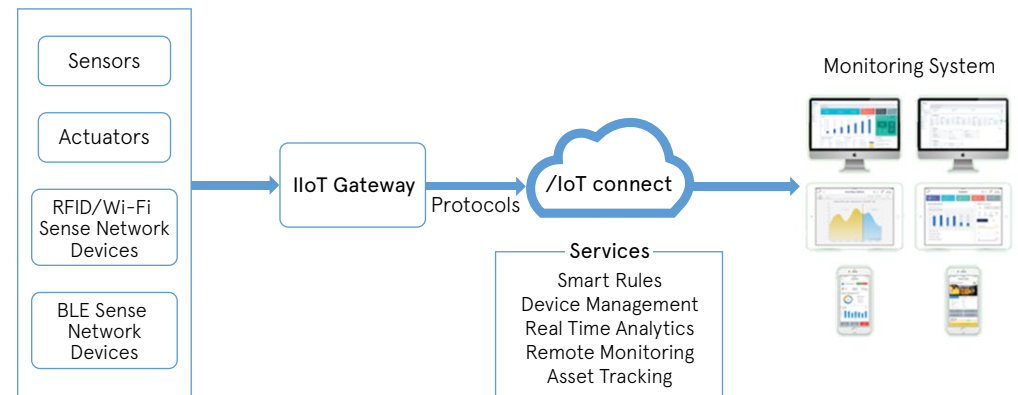
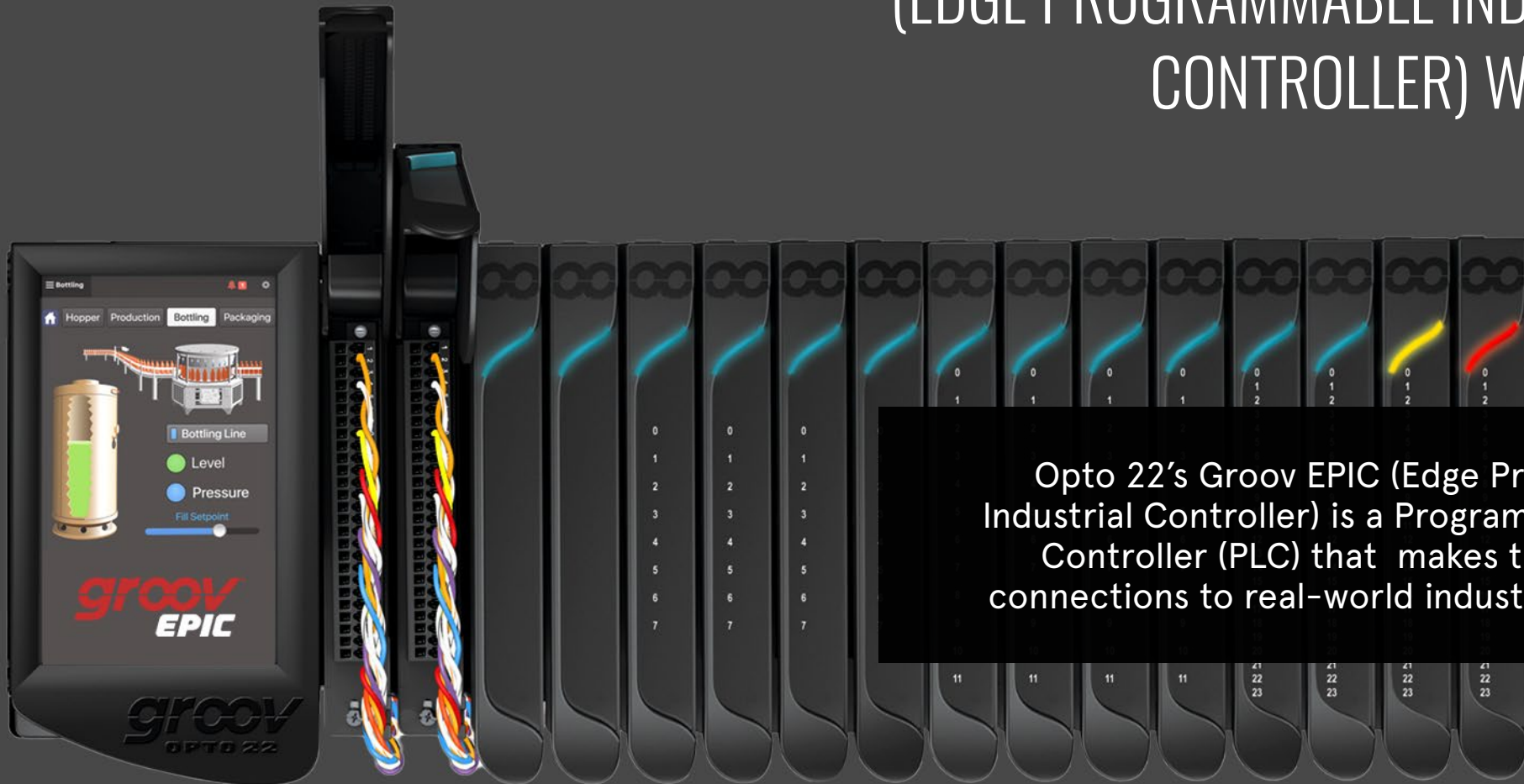

Figure 2: Block Diagram of Monitoring system using IloT Gateway

HOW TO INTERFACE OPTO22 GROOV EPIC (EDGE PROGRAMMABLE INDUSTRIAL CONTROLLER) WITH AWS



Opto 22's Groov EPIC (Edge Programmable Industrial Controller) is a Programmable Logic Controller (PLC) that makes the electrical connections to real-world industrial "things."

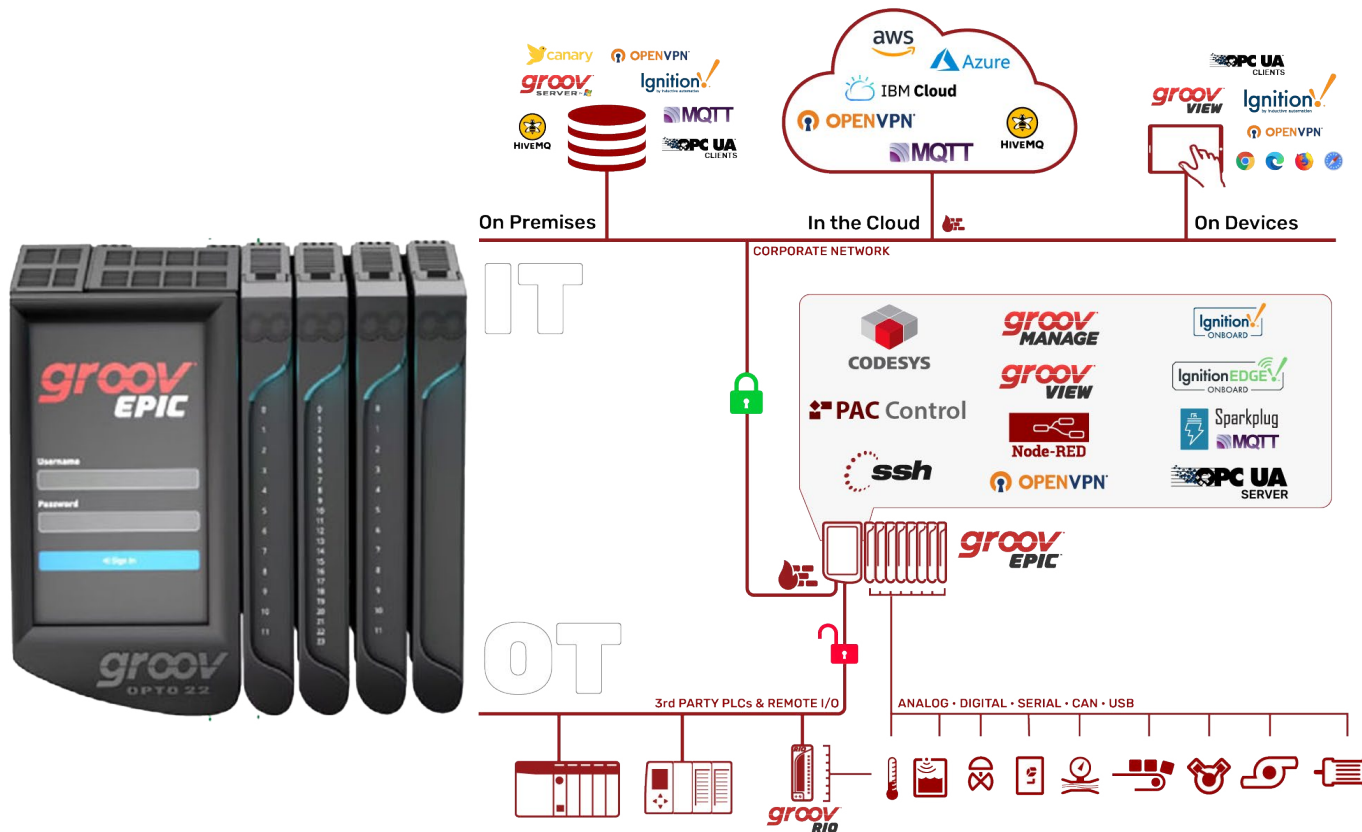

Figure 1: Groov EPIC Device and Software Architecture

These connections are inputs for sensors, switches, electrical loads, and outputs for actuators, motor controllers, etc. Many options are available for real-time management in demanding industrial environments. The edges need strong industrial equipment from the factory to the remote location and need not worry about processing power in difficult places.

The enterprise-hardened Groov EPIC platform securely connects operational technology (OT) and information technology (IT) through the collection, processing, visualisation, and exchange of information at the edge of the network.

The device has built-in software including Groov Manage, PAC Project Basic, CODESYS, Groov View, Node-RED, Ignition Edge®. It provides publish-subscribe data communication options using MQTT/Sparkplug.

This blog will explain how to configure this device for MQTT data communication with AWS (Amazon Web Services) using built-in Node-Red, an open-source software program.

Configuring Groov EPIC device for MQTT with AWS using Node-Red:

Node-RED provides an easy way to connect edge computing systems such as industrial automation controllers and edge I / O to cloud services such as Amazon Web Services™ (AWS) IoT, IBM Watson IoT™, and Microsoft® Azure®.

The Node-RED flow downloads data to the groove EPIC over the Internet (cloud-to-device) and also transmits data from the Groove EPIC to the cloud (device-to-cloud), connecting pre-assembled nodes (provided by device manufacturers or software developers) working together to make a flow. The flow provides the logic to achieve your goal.

Follow the steps below to configure node-red on the GroovEPIC device for the AWS server to send and receive data.

To launch Node-RED with Groov EPIC, use your computer and GroovManage. If you log in to Grove EPIC as an administrator, you will see the following screen.



Fig 2: Selecting Node-Red environment

From Groov Manage, select Node-RED.

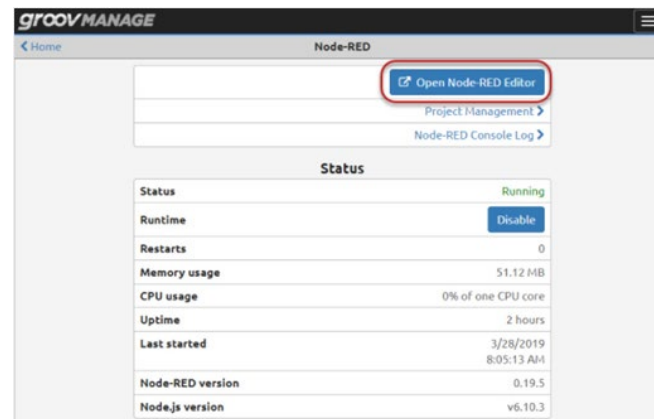

Fig 3: Open Node-Red editor

Click on Open Node-RED Editor. Since you've already gone through the authentication process by logging into Groove Manage, the Node-Red editor opens like the screenshot directly below. To open this Node-Red on your computer, use the EPIC Groov hostname / node-red as shown in the following figure.

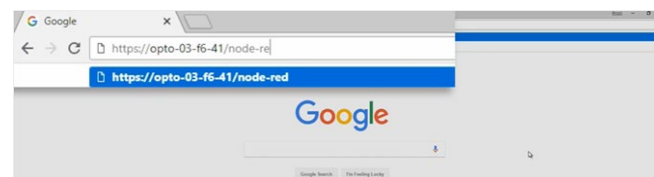

Fig4: URL to open localhost (Groov EPIC device) on the remote system (computer)

Finally, we get below node-red environment.



Fig5: Node-Red environment

Select the MQTT subscription node from the node menu and drag it into the flow diagram. Double click on this node to configure.

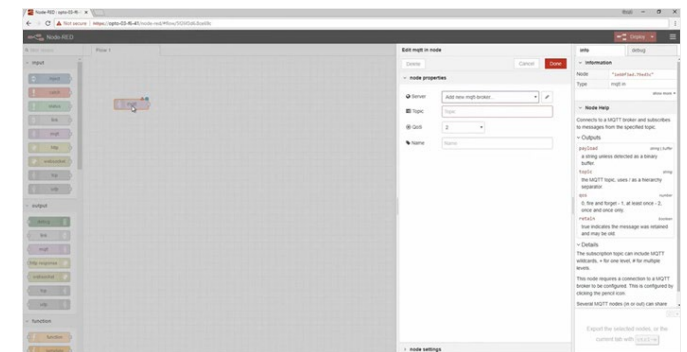

Fig6: Configuring Node-Red for MQTT (AWS server)

Copy the host from the Amazon AWS console and add it as shown below. The host is unique for each user, and the port is 8883. Give any name here; we will take it as a public broker.

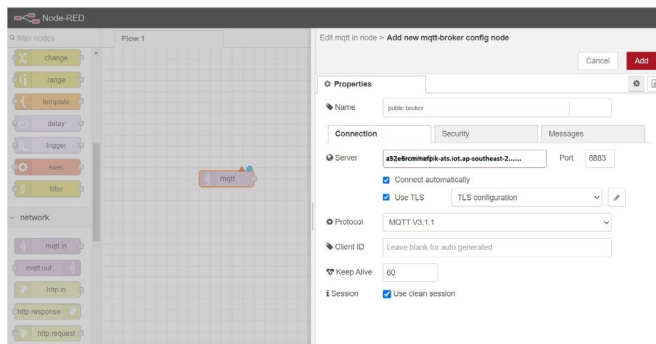

Fig 7: Adding AWS server address

Click on the TLS and edit. Upload the Downloaded certificates from the AWS. The following steps will help you to download the certificates.

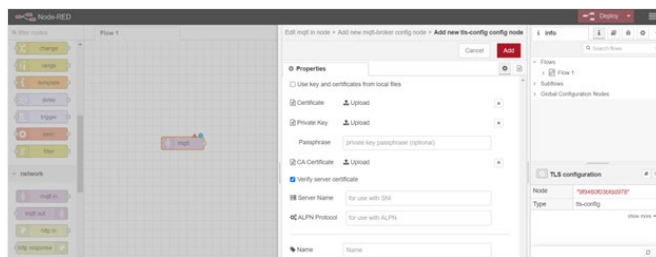

Fig 8: Adding certificates

Linking device with AWS and downloading certificates:

Go to things as shown below. Things represent the device. There can be multiple devices added to things. Here we have only one device that, is Groov EPIC. We will create a thing, and we will use that thing from the Node-RED to send some of the MQTT messages on the AWS IoT core. Click on the “create things” button and give any name to that thing. Click on next; it will generate the certificate needed to interact with the Groov EPIC. Download all the certificates and upload them to the TLS-config nodes.

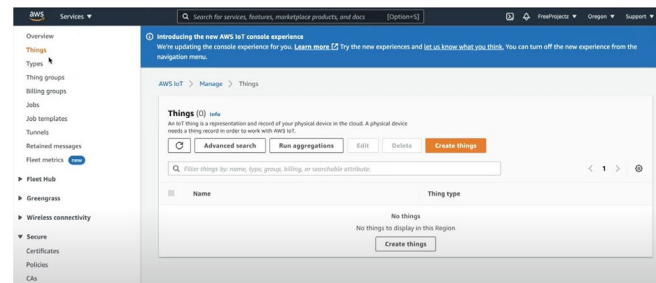

Fig 9: Creating Things device

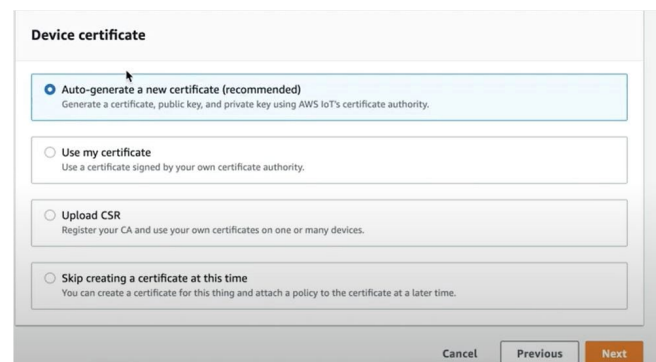

Fig 10: Generating certificates

After generating the certificates, click on create policy.

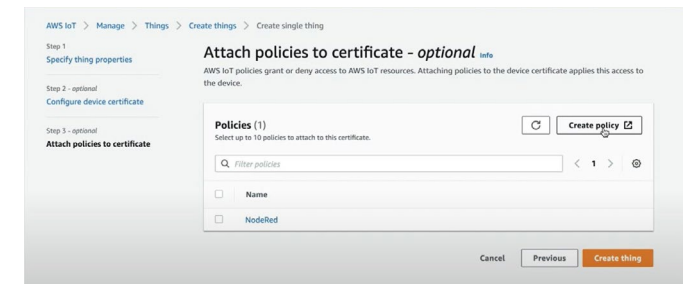

Fig 11: Adding Policies

Edit the policies as shown in the below figure:

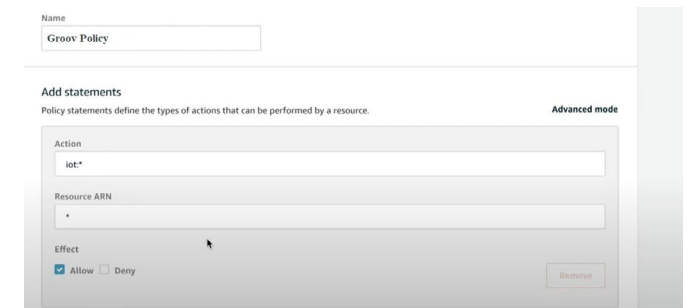

Fig 12: Editing Policies

Select the created Groov policy and click on the button create. After that, you can download the certificates.

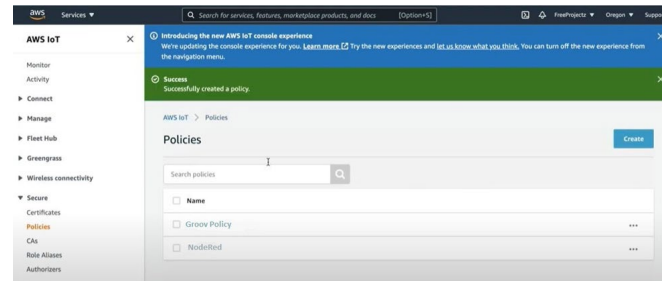

Fig 13: Selecting Policies

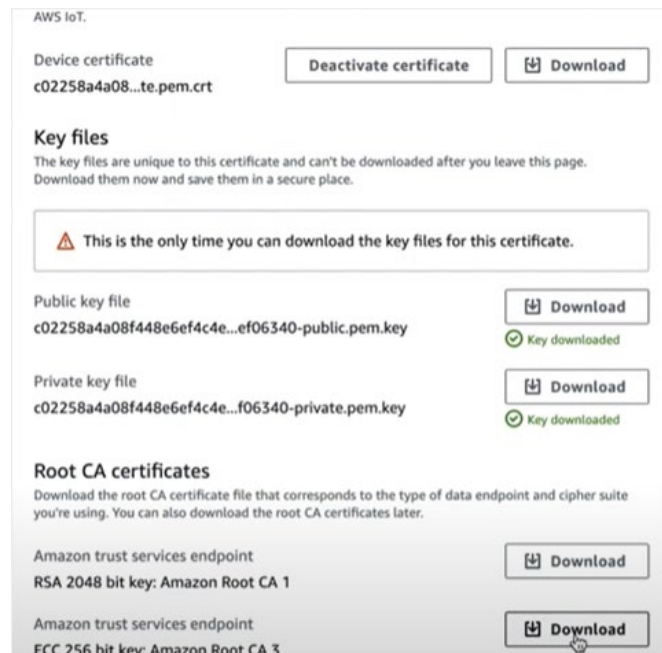

Fig 14: Download certificates and key files

Making an application to toggle a digital output:

Once the certificates are added, broker setup is completed, the next thing to look at is the topic. The topic namespace is an unmanaged way to identify your messages. Each client determines the topic of that device's messages. Let us add the topic "workshop/switch," as shown below.

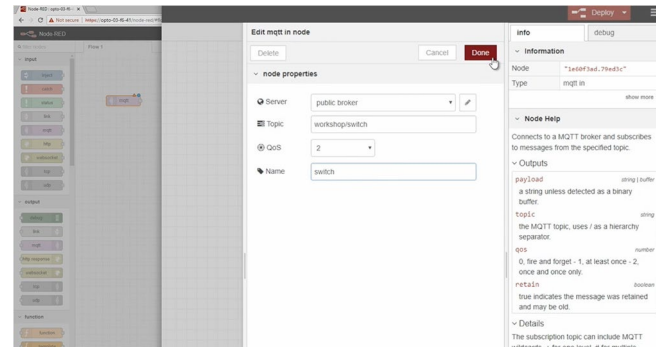

Fig 15: setting the MQTT topic to control digital I/O

After setting up the client, we use the switch method to toggle a light. To do that, we will use the SNAP PAC write node. These interface with the I/O modules installed on the Groov EPIC chassis. This will connect to the local host device since Node-RED is running on the Groov EPIC.

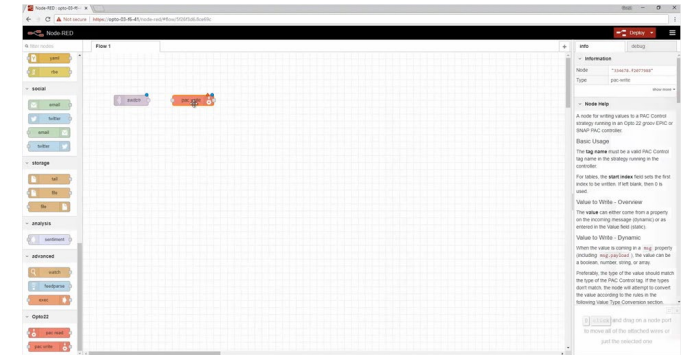

Fig 16: Creating SNAP PAC write node

Now edit the PAC write and fill the following as shown below:

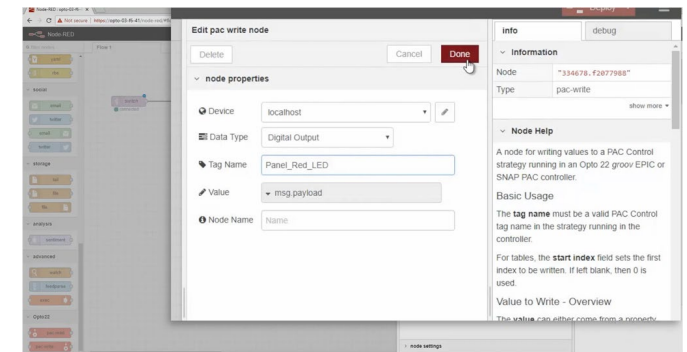

Fig 17: Editing SNAP PAC write node

Now you can publish and subscribe to any topic; in this case, the topic is "Workshop/switch." The client for subscribing and publishing can run on any field device or cloud application.

HOW PROGRAMMABLE LOGIC CONTROLLERS CAN BE USED TO **MONITOR VIBRATION** OF A ROTATING MACHINE?

The condition of a machine dictates its maintenance. To know the condition of a machine, you need to analyse the machine's vibration data. Most industries gather vibration data by implementing vibration monitoring techniques. These methods need the use of a portable data collector and a predetermined route of data collection points.





The collected vibration data is reviewed and compared with the trend data to determine any anomalies or machine failure. This process, however, wastes time and resources if the machines work as expected.

In large manufacturing plants with several rotating machines, vibration monitoring can be a hard task. It can be a challenge to determine the data collection routes and data collection frequency. These issues get compounded if different machines in a plant have different failure rates. Many plant managers thus tend to investigate multiple continuous vibration monitoring solutions. Such investigations often reveal that most permanent vibration monitoring sensors are incompatible with existing plant monitoring instrumentation systems such as programmable logic controllers (PLCs) etc.

The use of a vibration sensor and retro-reflective photoelectric sensor with a condition monitoring system (CMS) allows vibration acceleration, speed data, and alarms to be available directly onto the PLC system in real-time. In this way, the PLC can react instantaneously when a warning condition presents itself, whether by sending an alert on an HMI or giving the command to VFD to stop the machine from running altogether until the defective component is fixed or replaced.

Monitoring and diagnostic vibrations

Figure 1 includes a PLC, a CMS, a HMI, and sensors to measure and calculate the desired machine parameters. Any violation of limits results in the generation of corresponding messages, and the execution of the parameterised response. The control program can access these messages through a function block in the software.

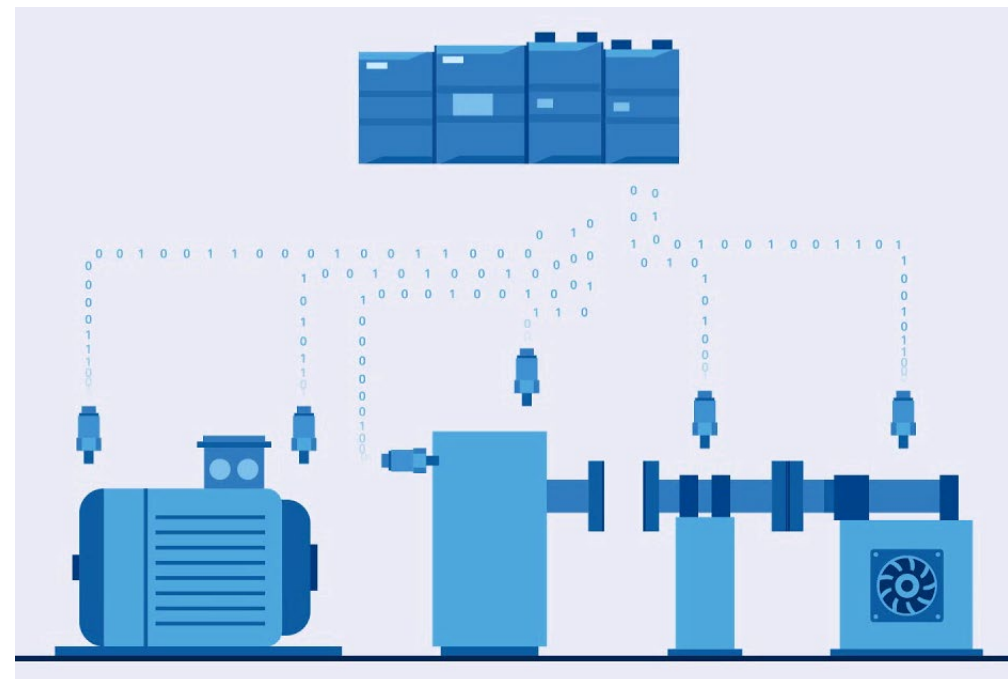

Figure 1: Vibration monitoring of motor using Condition monitoring system (CMS) and PLC

The measured variables are cyclically transmitted to the controller and recorded as a trend curve in the CMS. The trend curves can be displayed via the integrated web server.

The CMS enables you to calculate the following characteristic values:

- vRMS (root mean square velocity) is calculated based on the interval RMS value of vibration velocity.

- aRMS (root mean square acceleration) is calculated based on the interval RMS value of vibration acceleration.

Setting the warning and alarm limits

We will use an example to show how to determine the warning and alarm limits.

According to DIN ISO 10816-3, the following guide values apply for this type of machine:

Warning limit vRMS: The warning limit indicates that a significant change has already occurred, but the operation can continue. It is necessary to investigate the reasons for the changed vibration condition and eliminate it if necessary. According to DIN ISO 10816-3, if the vibration quantity increase (or decrease) exceeds 25 per cent of the upper limit value of the corresponding zone B, the changes must be considered essential, particularly when they suddenly happen.

We, therefore, recommend setting the warning limit to 25 percent of the upper limit value of the corresponding zone B higher than the basic value (the basic value is obtained from past operational experiences at this measuring point). The limit should not exceed 1.25 times the upper limit of zone B.

As no experience values are available at the beginning, the reference value measured when determining the normal operating state is taken as the basic value.

In this example, the warning limit is defined as follows:

$$\text{Warning limit } v_{RMS} = \text{basic value} + 0.25 \times \text{upper limit zone B}$$

$$\text{Warning limit } v_{RMS} = 0.8 \text{ mm/sec} + (0.25 \times 4.5 \text{ mm/})$$

$$\text{Warning limit } v_{RMS} = 1.925 \text{ mm/sec}$$

Alarm limit vRMS: The alarm limit intends to indicate that further operation may cause machine damage. If this limit is exceeded, immediate measures should be taken to reduce vibrations, or the machine must be shut down.

The DIN ISO 10816-3 recommends the limit to be located within zones C or D. Generally, the limit must not break 1.25 times the upper limit of zone C.

In this example, the upper limit of zone C is used as alarm limit:

$$\text{Alarm limit } v_{RMS} = 7.1 \text{ mm/sec}$$

Warning limit aRMS: The operator can use the value of the aRMS vibration acceleration averaged over a frequency range between 1 kHz and 10 kHz as bearing status monitoring. The suggested warning and alarm limits are based on practical experiences. There is no normative specification for limits. To determine the warning limit, 1 m/sec² is added to the measured reference value in the normal operating condition of the machine.

A reference value of 0.8 m/sec² is measured for the machine in the example.

$$\text{Warning limit } v_{RMS} = \text{basic value} + 1\text{m/sec}^2$$

$$\text{Warning limit } a_{RMS} = 1.8\text{m/sec}^2$$

Alarm limit aRMS: To determine the alarm limit, 2 m/sec² is added to the measured reference value in normal operating condition of the machine.

$$\text{Alarm limit } a_{RMS} = \text{basic value} + 2 \text{ m/sec}^2$$

$$\text{Alarm limit } a_{RMS} = \text{basic value} + 2.8 \text{ m/sec}^2$$

ISO 10816-3		Group 1		Group 2		
		Large machines 300 kW < power < 50 MW		Medium machines 15 KW < power < 300 kW		
in/sec peak	mm/sec rms	Motor height > 315 mm		Motor 160 mm < height < 315 mm		
0.61	11.0		Damage occurs			
0.39	7.1					
0.25	4.5		Restricted operation			
0.19	3.5		Unrestricted operation			
0.16	2.8					
0.13	2.3	Unrestricted operation				
0.08	1.4					
0.04	0.7	Newly commissioned machinery				
0.00	0.0					
Foundation		Rigid	Flexible	Rigid	Flexible	

Maximize Efficiency. Minimize Downtime.

- Harness the Power of Programmable Logic Controllers
- Optimize Performance with Real-time Vibration Monitoring
- Detect Potential Issues Before They Escalate
- Enhance Maintenance Efficiency and Extend Machine Lifespan

Unlock the Potential Today

Click here 

HOW TO DRIVE DC MOTOR WITH **SMART POWER ICS**

Electric motors are the The smart power IC integrates both the power supply devices and the control circuit on one chip. So far, research has focused on a high-voltage integrated circuit and a CMOS-compatible power IC.

These are special high-speed integrated circuits that drive multiphase motors such as brushless DC motors (BLDC) and provide the advanced control functions that are required for modern energy-efficient applications, such as variable speed, current vector control, and even sensor-less control.

Older controllers cannot be described as smart because they do not have any microprocessor command interfaces such as SPI (Serial Peripheral Interface), RS232 Serial, or CANBus. This is especially important as more and more industries want to power highly efficient motors.

The figure below shows the internal schematic block of a typical smart power IC. The inputs to the IC are microprocessor-style commands and it can accept torque or speed commands via direct analog voltage or SPI (Serial Peripheral Interface). This IC is not a general-purpose microprocessor, although it has a DSP-like engine at its core. The smart IC provides top-level, ready-to-use instructions for setting motor drive parameters, such as to adjust the output value or adjust the current gain. A single IC can be used to control the speed, torque, or voltage mode of BLDC three-phase motors. It can perform multiple functions including three-phase PWM signal generation, switching, current loop, speed loop, profile generation, hall sensor input, square encoder input and emergency stop processing, along with serial interface Input-output commands, and serial SPI data given at the same time.

When switching on or resetting, the IC checks the presence of the serial EEPROM in the I2C interface. With the serial EEPROM, the configuration commands stored on the chip are read and provide parametric information that can be used during operation. On the other hand, configuration information can be stored in the flash memory.

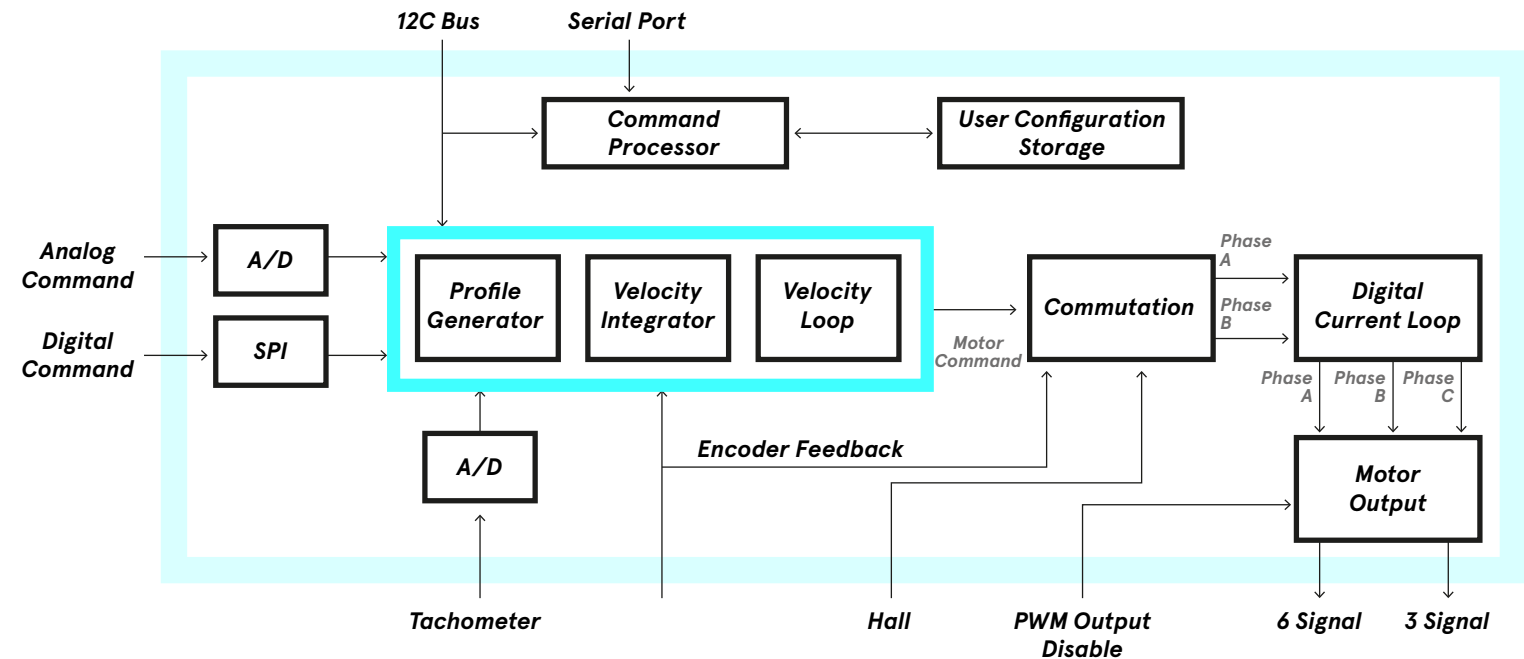

Figure : Smart motor controller power IC

If the initial configuration is not stored in flash or provided by the serial EEPROM, then the default values are used, and then the information would be sent over the serial port from a host device such as a microprocessor or PC. Depending upon the configuration of the control loop, the external analog signals can set speed or torque values. The serial peripheral interface or internal profile generator can also be used for configuration commands.

The current loop control takes place through the direct input of two analog signals that indicate the instantaneous current through the motor windings A and B. These signals are usually received by external series resistors or Hall sensors in the amplifier circuit. This analog current information is then combined with the current required for each phase to generate the symmetric 6 or 3 PWM signals.

The IC contains a number of safety functions, including emergency stop signal input, PWM output deactivation, and amplifier output signal deactivation, which can be used to turn the external amplifier circuit on and off. Expanding on the highly integrated MPC5775E microcontroller, the MCSPTR2A5775E motor control kit enables complex electric motor drive in the most efficient way for application targeting up to ISO 26262 ASIL D.

HOW TO MITIGATE **HARMONICS** GENERATED BY VFDS

A Variable Frequency Drive (VFD) controls the speed of an AC motor. The VFD enhances efficiency by limiting energy consumption and reducing equipment wear. Its use, however, may create power quality issues in the form of harmonics.

Adding Variable Frequency Drive (VFD) to control motor speed enhances efficiency by limiting energy consumption and reducing equipment wear. The use of VFD, however, may create power quality issues in the form of harmonics.

Harmonics are deviations from the desired model sinusoidal AC line voltage and current waveforms. These deviations, or harmonic distortions, generally have low magnitude. However, the magnitude can increase if there is greater use of power electronics, non-linear commercial and industrial loads, and VFDs. Harmonics can cause problems in the power system.

Higher-order harmonics may interfere with sensitive electronics such as programmable logic controllers (PLCs), distributed control systems (DCS), and communications systems. In contrast, lower-order harmonics can cause overheating in motors, transformers, and conductors.

Harmonics have a different acceptable level of distortion, defined by standards such as IEEE 519-1992.

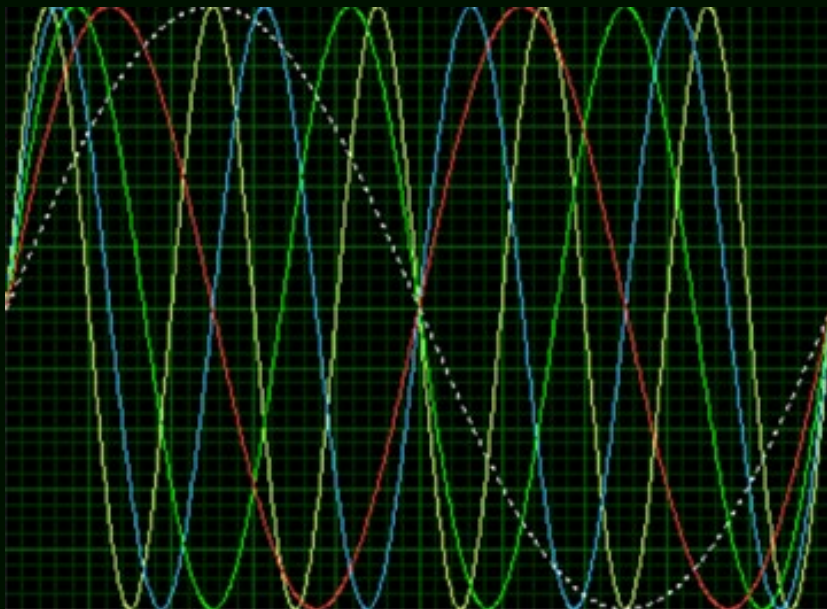

Figure 1: 5th-harmonic notching of current from a variable-frequency drive

VFD options for mitigating harmonics

Some power utilities now impose penalties for introducing harmonics onto their grid, incentivizing owners to reduce harmonics. You can mitigate harmonic distortions using several methods. A few involve an additional cost in the overall power system, whilst some techniques provide other benefits outside harmonic mitigation. The commonly used methods and their benefits for harmonic mitigation are as follows:

1. Line Reactors: AC line reactors will make the current drawn from the power line more sinusoidal. It reduces the input current distortion to 30-40 percent compared to 70-100 percent in case there is no reactor in the drive. The reactors are standard inclusions in drives of 5 hp and above.

The inclusion of a line reactor or an isolation transformer to attenuate harmonics gives you a low-cost, technically simple solution. However, this solution alleviates only higher-order harmonics and has minimal effect on the 5th and 7th harmonics.

The typical reactance is either AC or DC, delivering similar harmonic mitigation. You can use AC reactors to provide additional protection to the drive rectifier bridge. Reactors are typically rated from 1.5 percent to 5 percent, with 3 percent being the industry standard due to the diminishing returns delivered by higher levels and associated voltage drop issues.

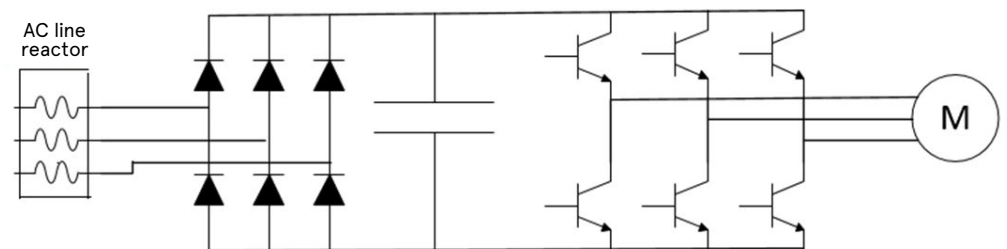

Figure 2: Line Reactors

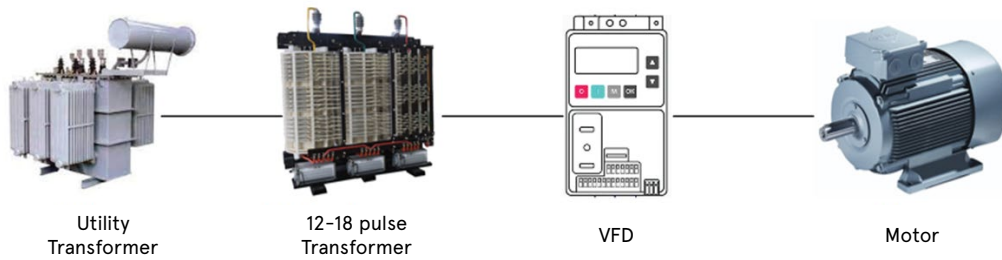

Figure 3: Multi-Pulse Drives (12 and 18-Pulse)

2. Multi-Pulse drives (12 and 18-Pulse):

You can also use 12-pulse drives and 18-pulse drives to diminish the harmonics. These drives contain multiple rectifiers and an expensive transformer with one primary and multiple secondary. Such configurations cancel some of the lower level, higher amplitude harmonic currents.

Current distortion at the input terminals is approximately 10 percent for 12-pulse drives and 5 percent for 18-pulse drives. The 18-pulse converter is the most cost-effective solution at 50 hp or higher.

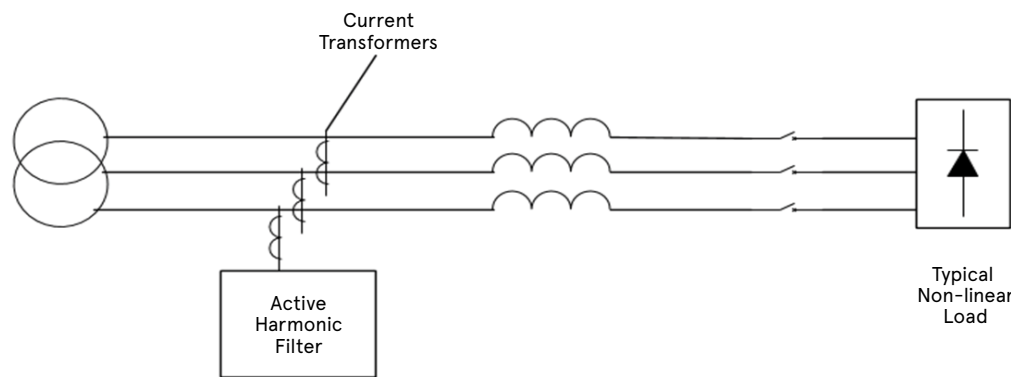

Figure 4: Active filter

3. Active harmonic filters: Active harmonic filters use smart electronics and IGBTs to inject harmonics of equal amplitude and opposite phases into the power system to correct the harmonics generated by non-linear loads. These systems are installed parallel to the utility lines. Sensors determine and monitor the quantity of corrective current that must be injected into the power system to provide a sinusoidal waveform.

Active harmonic filters can compensate for harmonic distortion and power factor, and one unit can compensate for multiple non-linear loads. The unit can operate at its maximum current rating without overloading, even if new loads are installed. You can install multiple active harmonic filters in parallel to supply corrective current for bigger applications. They can function appropriately if voltage imbalances exist. Active harmonic correction filters also can make an excellent retrofit for existing systems because they are shunt-connected devices. However, this technology has the drawbacks of high cost per amp and low energy efficiency.

4. Passive filters: Passive filters use a capacitive and inductive filter to block harmonics from being transferred to the electrical distribution system. A primary inductor uses relatively high impedance blocks to check the higher-order harmonics. The 5th and 7th order harmonics are reduced using a shunt-connected tuned reactor connected with a capacitor. These filters are cheaper than 12- 18-pulse converters and are slightly more tolerant of line imbalances but also have losses associated with using them. The use of passive filters in the installed drives increases the total cost by 200 to 500 percent, depending on the level of mitigation.

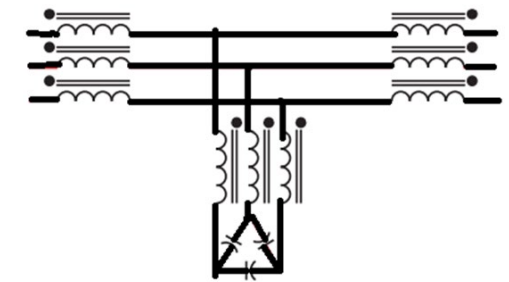

Figure 5: Passive filter

5. Active front end: The active front-end drive is a bi-directional power converter for the front end of a typical DC bus drive lineup. It is immune to voltage imbalance and is available in 10–2000 hp. You can use the converter on multiple drives with a single front end. It provides voltage sag ride-through capabilities, a unity power factor, and a regenerative power flow. Although the converter does not affect other harmonics and cannot retrofit into existing drives, it does reduce total harmonics at any load to 2–3 percent THD.

The active front-end drive is a newer technology for regenerative loads, such as test stands and centrifuges. It requires an inductive-capacitive filter to filter the high-frequency IGBT switching from the line.

The added technology introduced by the additional IGBTs increases the cost of the active front-end drive in many applications. Also, the capacitive filter and the IGBTs are not as robust as the simple and reliable magnetics and diode technology of the 18-pulse drives.

Farnell/Newark has a wide array of products to reduce harmonics caused by non-linear loads. You can apply several solutions to meet your harmonic requirements, facility limitations, and budget needs.

VFDs enabled with low harmonic solutions such as active front-end technology, 18-pulse arrangements, and active and passive harmonic filters have proven effective and can be configured to meet IEEE 519 standards.

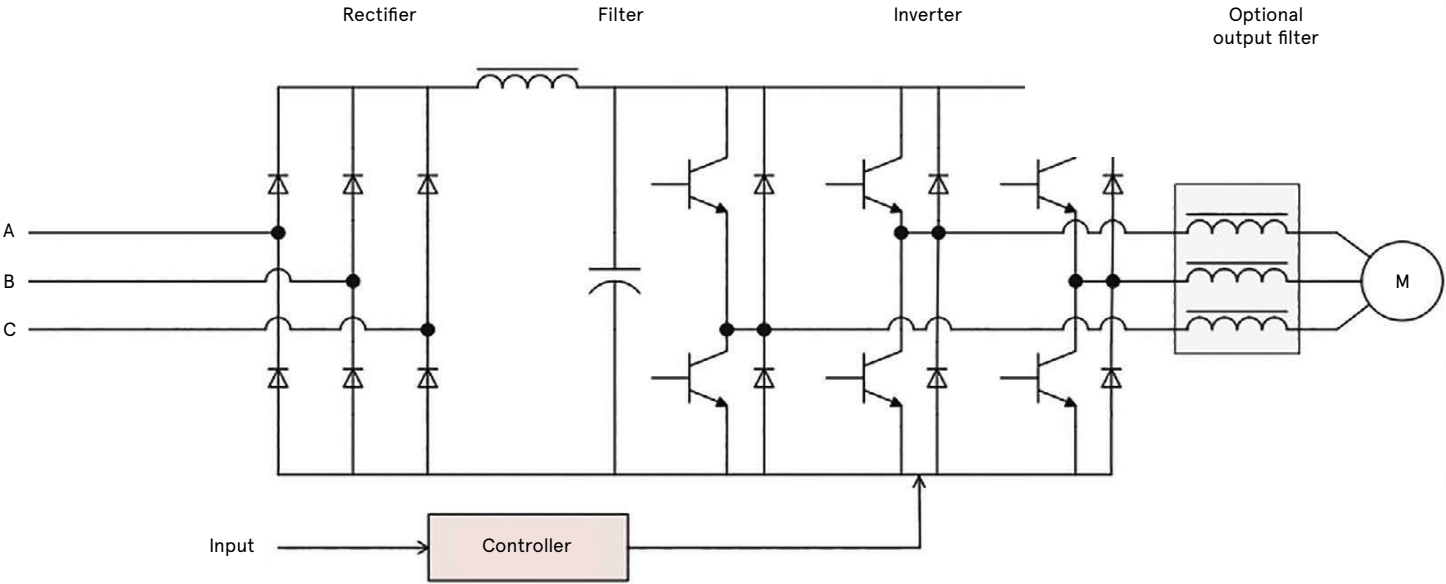

Figure 6: Active front end

Drive the future with unparalleled performance and precision Variable Frequency Drives

[Click here](#)



BUILD AND MAINTAIN YOUR INDUSTRIAL CONTROL PANEL FOR 20% LESS*

From the enclosure outside, the components within, and everything else that keeps them operating safely – engineers choose Multicomp Pro.

Developed by our engineers for engineers like you, Multicomp Pro products and components meet the quality standards engineers require and the value they need to build and maintain industrial control panels at a lower cost without sacrificing quality.

- > [Cable & Cable Management](#)
- > [Tools](#)
- > [Outside the Panel](#)
- > [Inside the Panel](#)
- > [Panels](#)
- > [Converters](#)

*Typically 20% less than other brands

[Learn more](#) 

multicomp PRO